



EEIG ERTMS Users Group
123-133 Rue Froissart, 1040 Brussels, Belgium
Tel: +32 (0)2 673.99.33 - TVA BE0455.935.830
Website: www.ertms.be E-mail: info@ertms.be

Principles

Hybrid ERTMS/ETCS Level 3

Ref: 16E042
Version: 1A
Date: 14/07/2017

Modification history

Version	Date	Modification / Description	Editor
0a	12/04/2016	Initial EUG version	RT
0b	03/05/2016	Further scenarios added, changes agreed in review session on 21/04/2016 partially implemented	RT
0c	24/06/2016	Implementation of changes agreed in review session on 21/04/2016 (all from EUG, 2/3 from NR)	RT
0d	22/12/2016	Restructuring and concentration on core principles	RT
0e	28/02/2017	EUG review and addition of timer definitions, scenarios and implementation example	RT
1-	18/05/2017	Review by EUG members and some external partners	RD
<u>1A</u>	<u>14/07/2017</u>	<u>Some small corrections and improvements</u>	<u>RD</u>

Table of Contents

1	Introduction.....	5
1.1	Purpose	5
1.2	The existing Level 3 concept according to the ERTMS/ETCS specifications.....	5
1.3	The Hybrid Level 3 concept	6
2	Documents & Terminology.....	8
2.1	Reference documents.....	8
2.2	Abbreviations.....	8
2.3	Definitions.....	8
3	Main principles for Hybrid Level 3	10
3.1	General.....	10
3.2	Definition of VSS states	10
3.3	Definition of train location.....	11
3.4	Definition of timers	13
3.5	Operation of trains treated as integer.....	15
3.6	Operation of trains not treated as integer	16
3.7	Operation of trains with lost integrity	16
3.8	Operation of trains without connection to the trackside	17
3.9	Sweeping of sections.....	18
4	Hazard mitigation.....	19
4.1	Introduction.....	19
4.2	Protection against non-connected trains	19
4.3	Protection for loss of integrity situations.....	20
4.4	Two reporting trains in one VSS	21
4.5	Protection against shadow train hazard	21
4.6	Rolling backwards.....	23
5	State machine for VSS.....	24
6	Annex A: Operational scenarios.....	28
	Scenario 1 - Normal running of a single train with integrity confirmed by external device	28
	Scenario 2 - Splitting of a composite train with integrity confirmed by external device	30
	Scenario 3 - Shadow train	32
	Scenario 4 - Start of Mission / End of Mission	34
	Scenario 5 - Integrity lost.....	36
	Scenario 6 - Connection lost and reconnect within session	38
	Scenario 7 - Connection lost and reconnect within session with release of VSS	40
	Scenario 8 – Sweeping, jumping and two trains in a VSS.....	42
	Scenario 9 – Ghost train.....	44

<u>7</u>	<u>Annex B: Mitigation of specification shortcomings.....</u>	<u>46</u>
<u>7.1</u>	<u>Introduction.....</u>	<u>46</u>
<u>7.2</u>	<u>Performance issue when leaving an RBC area.....</u>	<u>46</u>
<u>7.3</u>	<u>Performance issue after transition to SH mode.....</u>	<u>46</u>
<u>7.4</u>	<u>Protection against undetected train splitting.....</u>	<u>46</u>
<u>7.5</u>	<u>Unspecified reporting behaviour of integrity information.....</u>	<u>47</u>
<u>8</u>	<u>Annex C: Implementation examples.....</u>	<u>48</u>

List of Figures

Figure 1: Section conventions	9
Figure 2: Train location for integer train	12
Figure 3: Assumed end of the train location	13
Figure 4: Loss of train integrity	16
Figure 5: Propagation of "unknown" after disconnection during mission	20
Figure 6: Shadow train hazard	22
Figure 7: VSS section state diagram	24

List of Tables

Table 1: VSS states.....	11
Table 2: Transition between states for VSS sections.....	27

1 Introduction

1.1 Purpose

1.1.1.1 This paper describes a specific concept for the implementation of ERTMS/ETCS Level 3, the Hybrid Level 3 concept. The main characteristic of the concept is that it uses fixed virtual blocks for the separation of trains which are fitted with a train integrity monitoring system (TIMS), while a limited installation of trackside train detection is used for the separation of trains without TIMS, as well as for the handling of degraded situations.

1.1.1.2 The concept is defined in a generic way, which makes it applicable for all kinds of lines, from high density, high performance lines to low density lines.

1.1.1.3 The concept defines only the principles of the Hybrid Level 3. It is not a detailed system specification.

1.2 The existing Level 3 concept according to the ERTMS/ETCS specifications

1.2.1.1 The concept of Level 3 is defined in the SRS [1]. In Level 3 the train separation function (collision avoidance), which is performed by the trackside, is based on train position and train integrity confirmation, both reported by the on-board to the trackside. In Level 2, the train separation function is based on occupation status reported by trackside train detection devices.

1.2.1.2 It should be noted that Level 3 is sometimes considered to be equivalent to moving block. However, the SRS does not refer to moving block in the definition of Level 3. In a Level 3 implementation the block sections exist in a logical form in the trackside system. They can be fixed (virtual) blocks as well as moving (virtual) blocks. Both are possible and both are considered as Level 3 implementations.

1.2.2 Advantages of Level 3

1.2.2.1 The advantage of Level 3 is mainly a reduction of the trackside implementation cost, an improved performance, or a combination of both. The main cost saving in Level 3 is that in principle there is no need for trackside train detection. Only a reference for the train position remains necessary. Due to the absence of trackside train detection it is easy to achieve very short fixed virtual block sections just by adapting the configuration of the trackside system, or even moving block sections, without an increase of cost for additional trackside devices, thereby improving the performance at relatively low cost.

1.2.3 Pre-conditions for Level 3

1.2.3.1 In Level 3 the train separation function relies on the position, length and integrity status of the train. Each train needs to be fitted with a TIMS which allows to report the integrity status of the train to the on-board which uses that information in the position report to the trackside. Especially for variable composition trains (freight) there is not yet a reliable and operationally robust TIMS available.

- 1.2.3.1.1 Note that the specifications allow for the train integrity to be confirmed by the driver. This is however not considered as an acceptable solution for most lines, since it does not provide the required safety level. Only in situations where the risk of mistakes by driver is relatively low, this function could be acceptable.
- 1.2.3.2 In Level 3 the train length, acquired as train data, is particularly relevant for the safe separation of trains. The integrity of the train shall therefore only be confirmed in conjunction with a "safely" acquired train length.
- 1.2.3.3 In absence of trackside train detection, the whole Level 3 concept relies fully on the condition that the trackside knows at all times the position and integrity status of each train or vehicle that is physically present in the area under its control. The problem is that in practice this condition cannot always be fulfilled. The train is not visible anymore for the trackside when there is no connection, e.g. the on-board enters shunting mode, is switched off intentionally (NP mode) or loses the radio connection. Even if the trackside remembers the last reported position of the train and the area in which the train was authorised to move, there is no guarantee that the train will stay within this area. There could be reasons to move the train under the supervision of operational procedures. The train could also move without any authorisation. Without trackside train detection, there is no way for the trackside to know the location of such a train in a sufficiently reliable way.
- 1.2.3.4 In case of switching on/off the trackside system (intentional restart or due to crash) it would have no knowledge at all of the trains in its area. Recovering from this situation would be cumbersome (sweeping of the whole trackside system area) and could require a long time.
- 1.2.3.5 In order to mitigate the problems related to these pre-conditions, while still preserving the advantages of Level 3, the Hybrid Level 3 concept was developed. This concept is presented in the next chapter.

1.3 The Hybrid Level 3 concept

- 1.3.1.1 The Hybrid Level 3 concept described in this document is based on the following features:
 - 1.3.1.1.1 It is based on the existing Baseline 3 Release 2 set of specifications, with corrections defined in the agreed solution of CR940 [2]. These corrected specifications can be used without any additional functions or features. Alternatively, B3R2 without these corrections can be used. In that case, see the proposed mitigations in annex B.
 - 1.3.1.1.2 It uses fixed virtual blocks. This is not a fundamental need of the concept. It is just for pragmatic reasons. In comparison to moving blocks, fixed virtual blocks have in several implementations less impact on the existing trackside systems such as the RBC, interlocking and traffic control centre as well as on the operational procedures. By reducing the length of the virtual blocks the performance can be similar to moving blocks, which means that the performance benefit is not compromised.
 - 1.3.1.1.3 It uses a limited implementation of trackside train detection. With that, both problems related to the Level 3 pre-conditions can be mitigated. Trains which are not reporting

confirmed integrity can still be authorised to run on the line, albeit with longer, but still acceptable, headways. Trains which are disconnected from the Hybrid Level 3 (HL3) trackside are no longer lost. They are still visible by means of the trackside train detection, which facilitates operational movements of disconnected trains, protection against unauthorised disconnected trains, and recovery after a crash of the HL3 trackside system. In addition, trackside train detection can improve performance by providing a faster release of critical infrastructure (e.g. points) than what can be achieved on the basis of the position reports.

- 1.3.1.1.4 It uses the status of the virtual blocks for the train separation function. The underlying trackside train detection is only used, together with the position reports, to determine the status of the virtual blocks.
- 1.3.1.1.5 It aims to minimise any possible impact on the harmonised operational rules which are defined for Level 2 (by using a limited implementation of trackside train detection).
- 1.3.1.2 If the installation of trackside train detection is implemented by axle counters, which are restricted to the areas where the points are located, and possibly the level crossings, the cost will be only a fraction of the cost to fit the whole line with train detection (axle counter heads). The whole stretch of track between the point areas is implemented as one large trackside train detection section. This large physical section is then split into as many virtual sections as necessary for the intended performance. In the points area power and cables are present anyway to operate the points. It is on the relatively long line between the point areas where the main cost savings are achieved.
- 1.3.1.3 It can be used on existing lines, which are already fitted with train detection, to provide a cost effective way to increase the capacity of the line, specifically in the peak hours. During the off-peak hours, trains without TIM could be scheduled, e.g. freight trains. Therefore, the concept is beneficial on the assumption that the majority of trains is fitted with a TIMS.
- 1.3.1.4 It can also be used on low density lines, where the fitment of a few train detection devices around the points (e.g. axle counters) together with a HL3 trackside system would provide a cost effective way to achieve an ETCS implementation.
- 1.3.1.5 It should be noted that the Hybrid Level 3 concept is by no means intended to be the only Level 3 concept.
- 1.3.1.6 The Hybrid Level 3 concept can deliver the same performance as a moving block concept if the virtual block sections are sufficiently small.
- 1.3.1.7 Since there are no easy solutions for the problems related to Level 3 without any trackside train detection, the Hybrid Level 3 concept is a pragmatic and flexible solution to start with the implementation of Level 3.
- 1.3.1.8 This Hybrid Level 3 concept is further developed in detail in the following chapters.

2 Documents & Terminology

2.1 Reference documents

- [1] *ERTMS/ETCS Subset-026: System Requirements Specification 3.6.0.*
- [2] *ETCS Change Request 940: Minimum safe rear end position and position reporting ambiguities.*
- [3] *ERTMS/ETCS Subset-023: Glossary of Terms and Abbreviations 3.3.0.*
- [4] *COMMISSION REGULATION (EU) No 1302/2014 of 18 November 2014 concerning a technical specification for interoperability relating to the ‘rolling stock — locomotives and passenger rolling stock’ subsystem of the rail system in the European Union.*
- [5] *COMMISSION REGULATION (EU) No 321/2013 of 13 March 2013 concerning the technical specification for interoperability relating to the subsystem ‘rolling stock — freight wagons’ of the rail system in the European Union.*
- [6] *ERTMS/ETCS Subset-093 GSM-R Interfaces Class 1 Requirements 2.3.0.*

2.2 Abbreviations

Note: Abbreviations already defined in [3] are not repeated on this section.

CES	Conditional Emergency Stop
EoM	End of Mission
HL3	Hybrid Level 3
N/A	Not Applicable
PTD	Positive Train Detection (based on position reports from trains)
RSMA	Request to shorten MA
SMA	Shortened MA
SMB	Stop Marker Board
SoM	Start of Mission
TIMS	Train Integrity Monitoring System
TTD	Trackside Train Detection (using conventional methods)
VSS	Virtual sub-section

2.3 Definitions

- VSS: A virtual sub-section, corresponding to a sub-division of a TTD section for which the occupation status is determined using both PTD and TTD information. See [Figure 1](#) ~~Figure 1~~
- TTD: A section defined by a conventional trackside train detection system, e.g. track-circuits or axle-counters.
- PTD: Detection of the train location based on information received from the train in the position report (position, integrity status,

- safe train length) and, in case of a non-integer train, the train data train length.
- Train location: This represents the trackside view of the track currently occupied by a train. See 3.3 for detailed explanation.
- Safe Rear Margin: This is a distance the trackside is adding to the confirmed train's rear end as an additional safety margin.
- Chasing train: Train that is following another train at a "short" distance. "Short" is relative and depends on the trackside configuration, block length, speed, etc.
- Chased train: This is the train in advance of a chasing train (see also chasing train), running in the same direction.
- Ghost train: A ghost train is either an physical object that is present on the track and detected by TTD, but that is unknown to the trackside system by means of PTD (no radio communication), or it is a virtual object which seems to occupy the track due -It could be an actual train without radio communication or to a trackside failure.
- Shadow train ~~A train unknown to the trackside system by means of PTD ghost train~~ that is following a train operating normally in L3.
- Integer train: A train which allows the trackside to release infrastructure in rear of the train based on its position reports.
- Non-integer train: A train which does not allow the trackside to release infrastructure in rear of the train based on its position reports.
- Connected train A train with an established safe radio connection to the trackside
- Not connected train A train without an established safe radio connection to the trackside

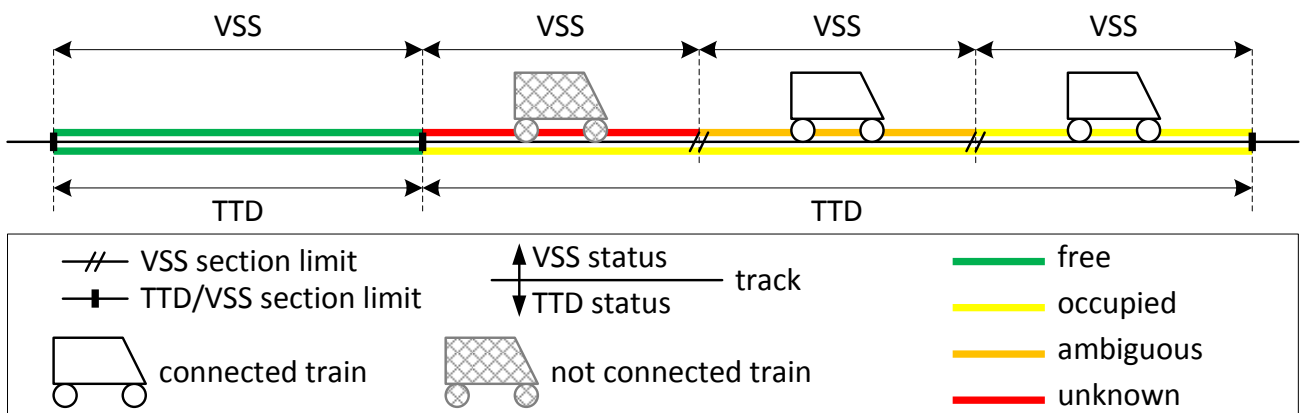

Figure 1: Section conventions

3 Main principles for Hybrid Level 3

3.1 General

- 3.1.1.1 The concept in this document is defined as a level 3 only implementation. It means that level 3 is the only level in the priority list sent by trackside when a train enters the Hybrid level 3 area. Mixed level implementations are in principle possible, but are not within the scope of this document.
- 3.1.1.2 TTD sections (including those containing movable elements) can be divided into several VSS sections.
- 3.1.1.3 Note: It is an implementation decision whether movable elements can only be moved when the corresponding TTD is free.
- 3.1.1.4 Note: The introduction of VSS does not change the principles of route setting and handling of MAs since VSS are treated in the same way as sections in level 2. Also, the principles for placing marker boards do not need to change compared to level 2.
- 3.1.1.5 TTD information is considered as safe, i.e. reporting free only if no train is present on the TTD section. As a result, all VSS on a free TTD can be considered as “free”.
- 3.1.1.6 The calculation of the safe rear end of a train relies on the train length of the train data. The reported train length in the train data of an integer train is considered as safe data, i.e. covering the actual train length and updated if the train length changes e.g. because of splitting or joining.

3.2 Definition of VSS states

- 3.2.1.1 Besides the ~~usual~~ two states (free, occupied) which ~~also at least~~ exist for a TTD (depending on the implementation there may be other logical states), two additional states are needed for a VSS to cover all operational situations. State "unknown" when there is no certainty if the VSS is “occupied” or not. State "ambiguous" when the VSS is known to be occupied by a (connected) train, but when it is unsure whether another (not connected) train is also present on the same VSS.
 - 3.2.1.1.1 Note: The distinction between "ambiguous" and "unknown" provides a convenient way to manage potentially hazardous situations. See the scenarios in annex A for some examples.
 - 3.2.1.2 Each VSS is in one of the states defined in the table below. The transitions are defined in section 5.

VSS state	Description
Free	The trackside is certain that no train is located on the VSS.
Occupied	The trackside has information from a position report that an integer train is located on the VSS and the trackside is certain that no other vehicle is located in rear of this train on the same VSS.
Ambiguous	The trackside has information from a position report that a train is

	located on the VSS and the trackside is NOT certain that no other vehicle is located in rear of this train on the same VSS.
Unknown	The trackside has no information from a position report that a train is located on the VSS, but it is not certain that the VSS is free.

Table 1: VSS states

3.2.1.3 The status of a VSS is derived from TTD occupancy information and train position reports.

3.2.1.4 For the purpose of authorising train movements and the indication to the traffic controller, only the VSS state "free" needs to be individually distinguished. All other states can be treated as if the VSS is "occupied". This could enable an easy integration of HL3 with existing trackside systems as explained in chapter 1.3.

3.3 Definition of train location

3.3.1.1 The term "train location" defines the trackside view of the stretch of track that is currently occupied by a connected train. The granularity of the train location is one VSS. The front end of the train location is not depending on the integrity status whereas the rear end of the train location is different (confirmed for an integer train or assumed for a non-integer train).

3.3.1.2 The front and rear end of the train location are considered independently from each other. If information of the front and rear end is received together, i.e. one position report, they are treated as two independent events, and the front end is processed first.

3.3.2 Front end of the train location

3.3.2.1 When the trackside receives the confirmation that the max safe front end of the train has entered a VSS (through position reports), it considers the train to be located on this VSS and all preceding VSS up to the last VSS currently covered by the train location.

3.3.2.1.1 Exception 1: As long as the min safe front end is in rear of the EOA, the train location shall not be considered to extend in advance of the EOA. The exception is to avoid treating the next VSS in advance of the MA as "occupied", which would prevent sending a new FS MA over it. The consequence of this exception is that the train may have physically entered the VSS in advance of the EOA, while the state of this VSS is still "free". This risk can be mitigated by forbidding opposing movements on VSS limits. For TTD limits this risk does not exist (train in advance of EOA would be detected by TTD).

3.3.2.1.2 Exception 2: As long as the TTD where the max safe front end is reported is free, the train location is not extended onto the VSS which are part of this free TTD. This avoids setting a VSS to "occupied" before the train physically entered it and therefore helps when cancelling routes or changing the train orientation.

3.3.2.2 Updating the front end of the train position does not depend on the integrity status in the position report.

3.3.3 Confirmed rear end of the train location

3.3.3.1 For an integer train the confirmed rear end of the train location is derived from the estimated front end and the safe train length of the last position report with “integrity confirmed” as well as from TTD information confirming that the train is not located on a VSS

3.3.3.1.1 See [Figure 2](#) for an example which shows how the train location is derived from the PTD and TTD information.

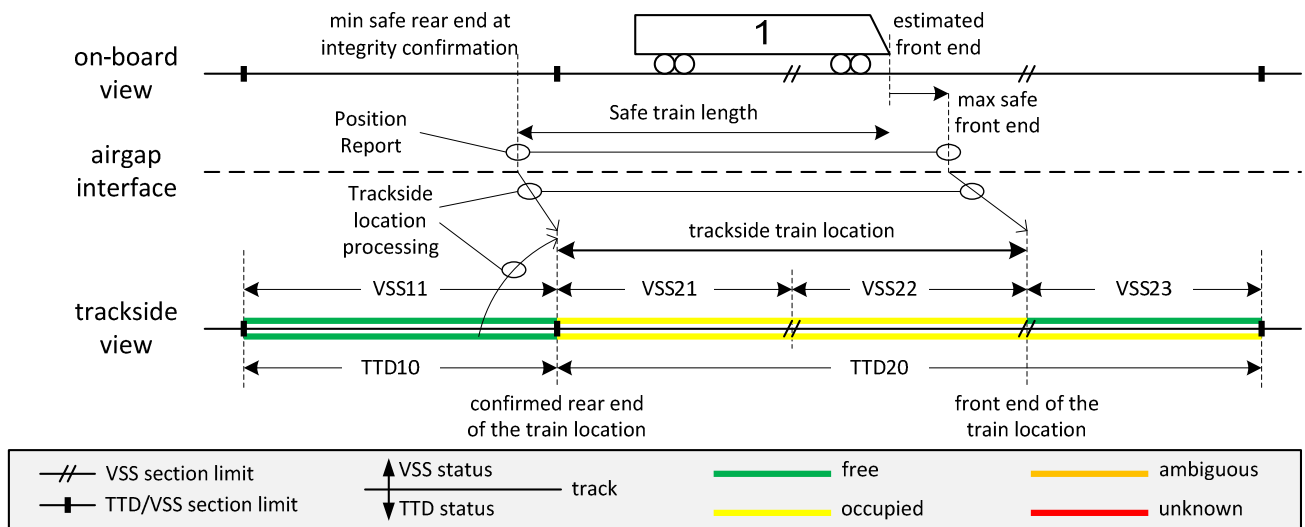

Figure 2: Train location for integer train

3.3.3.2 Note: The train is not located anymore on a VSS and all preceding VSS (i.e. the confirmed rear end of the train location is moved) when the trackside receives the confirmation that the rear end of the train has left a VSS.

3.3.3.3 Note: It is up to the specific trackside implementation whether an integrity confirmation by driver is taken into account for updating the confirmed rear end of the train location or not.

3.3.3.4 Note: The confirmed rear end of the train location is never updated by position reports with the integrity status “Lost” or “No information available”.

3.3.3.5 The confirmed rear end of the train location is never updated by position reports of on-board in the modes Sleeping or Non-Leading. ~~The on-board of the leading train part sends the length of the complete train, including the sleeping/non-leading part.~~

3.3.3.6 If an update of the confirmed rear end of the train location by TTD information would lead to a train located on no VSS anymore, the train location front end is considered to be located on the following VSS. This is to avoid losing the train location due to delayed PTD information (“jumping train”).

3.3.4 Assumed rear end of the train location

3.3.4.1 For a non-integer train the position of the rear end of the train location can only be assumed since there is no positive confirmation of its location.

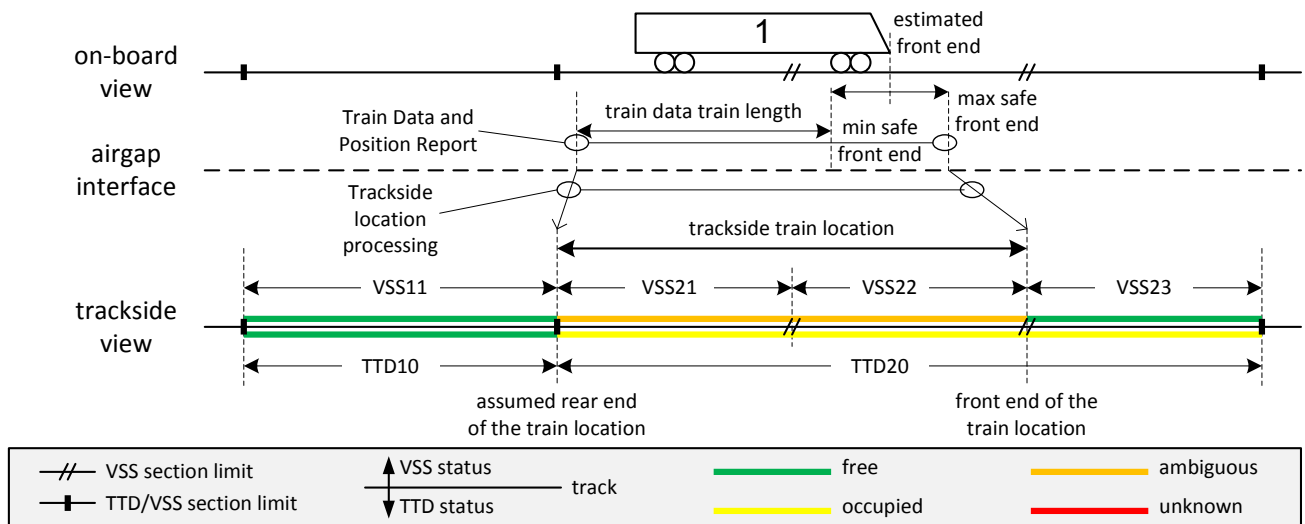

Figure 3: Assumed end of the train location

- 3.3.4.2 The assumed rear end of the train location is derived from the train length of the train data and the min safe front end of the last position report of a train as well as from TTD information confirming that the train is not located on a VSS.
- 3.3.4.3 Note: The train is not located anymore on a VSS and all preceding VSS (i.e. the assumed rear end of the train location is moved) when the trackside receives the information that the rear end of the train has left a VSS.
- 3.3.4.3.1 Since the assumed rear end of the train location is only "assumed" it can never be used to clear a VSS in rear. Therefore the VSS that was left by the assumed rear end of the train is not set to "free", but to "unknown".
- 3.3.4.4 If an update of the assumed rear end of the train location by TTD information would lead to a train located on no VSS anymore, the train location front end is considered to be located on the following VSS. This is to avoid losing the train location due to delayed PTD information ("jumping train").
- 3.3.4.5 On an ambiguous VSS the assumed rear end is used for the train location. This to prevent that for an integer train the L TRAINLENTGH is used for the shadow timer when leaving the TTD AND to prevent a 'train length' change if temporarily reporting "no integrity info".

3.4 Definition of timers

3.4.1 Waiting timers

- 3.4.1.1 Waiting timers are implemented in the trackside to avoid unnecessary changes in the state of a VSS due to the asynchronicity of train position, train integrity and TTD information.
- 3.4.1.1.1 Justification: Such unnecessary VSS state changes would have a negative impact on operation and performance.

- 3.4.1.1.2 A waiting timer may be configured with or without a stop event. Without a stop event, once started it will always run until it expires and will stay in the "expired" state. It will be reset when the start condition is met again.
- 3.4.1.2 A "mute timer" is assigned to each train. For usage see 3.8.
- 3.4.1.2.1 The "mute timer" runs continuously and is reset each time when information is received from the train.
- 3.4.1.3 The "wait integrity timer" is assigned to each train. For usage see 3.7.
- 3.4.1.3.1 A "wait integrity timer" runs continuously for every train and is reset each time when integrity confirmation is received from the train and no change of train data train length has been reported since the previous position report.
- 3.4.1.4 A "shadow train timer A" is assigned to each TTD for each direction. For usage see 4.5.
- 3.4.1.4.1 Start event:
 - a) (TTD becomes free) AND (the last VSS of the TTD was in state "ambiguous" at the moment when the TTD becomes free)
- 3.4.1.4.2 Stop events: None
- 3.4.1.5 A "shadow train timer B" is assigned to each TTD for each direction. For usage see 4.5.
- 3.4.1.5.1 Start event:
 - a) (the last VSS of the TTD changes from "ambiguous" to "unknown" because an integer train reports that he has left the TTD) AND (the reported min-safe-rear-end of this train is within the distance that can be covered at the reported speed within the "shadow train timer B" from the TTD limit)
- 3.4.1.5.2 Stop events: None
- 3.4.1.5.3 Note: The second condition in the start event mitigates the risk due to delays in the position report.
- 3.4.2 Propagation timers**
- 3.4.2.1 Propagation timers are implemented in the trackside to avoid unnecessary propagation of the state "unknown" to VSS sections for which there is no immediate risk that a rail vehicle could be located on them.
- 3.4.2.1.1 Justification: An immediate propagation, without timer, would have a negative impact on operation and performance.
- 3.4.2.1.2 A propagation timer may be configured with or without a stop event. Without a stop event, once started it will always run until it expires and will stay in the "expired" state. It will be reset when the start condition is met again.
- 3.4.2.1.3 If a start or stop event contains more than one numbered condition (a, b, c), these conditions shall be combined with and OR, i.e. any of these conditions will trigger the start/stop event.
- 3.4.2.2 A "disconnect propagation timer" is assigned to each VSS. For usage see 4.2.14.1.1.

3.4.2.2.1 Start event:

- a) The “mute timer” of a train located on the VSS expires.

3.4.2.2.2 Stop event:

- a) The connection of the train is restored.

3.4.2.3 A “ghost train propagation timer” is assigned to each TTD. For usage see [4.2.24.1.2](#).

3.4.2.3.1 Start events:

- a) TTD becomes “occupied” without a train located on it.
- b) TTD becomes “occupied” without an MA associated with it.

3.4.2.3.2 Stop events: None

3.4.2.4 An “integrity loss propagation timer” is assigned to each VSS. For usage see [4.2.2.14.1.2.1](#).

3.4.2.4.1 Start events (only applicable for a train on a VSS in state “occupied”):

- a) information integrity lost received
- b) integrity wait timer expired
- c) train reports a change of train data train length

Note that these events also trigger a transition of the VSS to state "ambiguous".

3.4.2.4.2 Stop events:

- a) train reports confirmed integrity again with unchanged train data train length (not for start event c)
- b) VSS state changes to “occupied” or to “free”

3.4.2.5 The propagation timers can be configured to be location and direction specific. This allows them to take into account the need to deviate in locations where either changing direction, rolling back and/or ghost train movements are less likely within a specific time.

3.5 Operation of trains treated as integer

3.5.1.1 The trackside will release infrastructure based on position reports from a train reporting confirmed integrity. The VSS that the train leaves will become “free” if there is no shadow train risk (see 4.5).

3.5.1.2 A train that reports “no integrity information available”, after having reported "confirmed integrity", is treated as integer until a position report with no integrity information is received after the "wait integrity timer" has expired.

3.5.1.2.1 Note: This to avoid that an intermediate position report without integrity confirmation would lead immediately to substantial operational impact.

3.5.1.3 The performance on the line depends on the time delay between the moment when an integer train leaves a VSS and the moment when this VSS changes its state to "free". This delay time depends on the frequency of the position reports and integrity confirmation. To achieve an optimum performance the trackside should request frequent position reports.

3.6 Operation of trains not treated as integer

3.6.1.1 The trackside will not release infrastructure based on position reports from a train that is not treated as integer. The VSS that the train leaves will become “unknown”. These sections will be set to “free” when the whole TTD becomes free. Thus, this corresponds to a system without virtual sub-sectioning.

3.7 Operation of trains with lost integrity

3.7.1 Introduction

3.7.1.1 When a train reports “integrity lost” it can, from the train protection point of view, continue its mission. If a coupling is indeed physically broken (wagons or carriages decoupled from the original train) and not a failure in the TIMS function, both train parts will be braked to standstill according to requirement 4.2.4.2.1. (4) in [4] and requirement 4.2.4.3.1 in [5].

3.7.1.1.1 Note: The trackside will not release infrastructure based on position reports from a train that reports “integrity lost”, i.e. a train that is not treated as integer. The VSS that the train leaves will become “unknown”. These sections will be set to “free” when the whole TTD becomes free. Thus, this corresponds to a system without virtual sub-sectioning.

3.7.1.2 The reported integrity loss of Train 1 in [Figure 4](#) does not impact the mission of Train 1 but the trackside will not be able to extend the FS MA for Train 2.

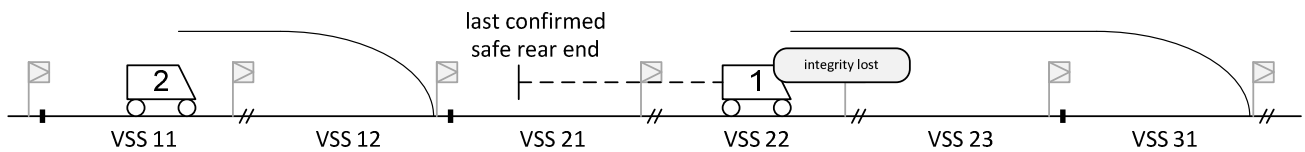

Figure 4: Loss of train integrity

3.7.2 Chasing train has an MA ending before the TTD section with the loss of integrity

3.7.2.1 When the chasing train does not have an MA ending inside the TTD section where the chased train is located when it loses its integrity, the impact is the same as for a train following a train not reporting confirmed integrity.

3.7.3 Chasing train has an MA ending in the TTD section with the loss of integrity

3.7.3.1 When the chasing train does have an MA ending inside the same TTD section where the chased train is located when it loses its integrity, the chasing train can be impacted.

3.7.3.2 At the moment the chased train reports “loss of integrity”, a changed train data train length or the “wait integrity timer” expires, the VSS sections, in which the train is located, are considered as “ambiguous”. They will become “unknown” when the train exits them (based on the length in train data and the min safe front end).

3.7.3.3 Then two scenarios are possible:

- a) The chased train (Train 1) frees the whole TTD section before the chasing train enters the TTD section. In that case all the VSS sections in this TTD change to

free and the FS MA can be extended till the end of the TTD section. The impact is the same as for a train following a train not reporting confirmed integrity.

- b) The chasing train (Train 2) enters the TTD section before the chased train leaves it. In that case, the VSS sections remain “unknown” and the chasing train has to operate in OS or in SR till the end of the TTD section. If Train 2 is integer, this results in sweeping those VSS enabling the sending of FS MAs to a following train on the same TTD. The sections would also be cleared if the whole TTD becomes free.

3.7.3.4 Note: If the Infra Manager wants to avoid this operational impact of sweeping, a FS MA should not be extended onto an TTD when a loss of integrity is detected on this TTD.

3.8 Operation of trains without connection to the trackside

3.8.1 Train disconnection

3.8.1.1 According to [1], the communication session is considered as lost by the trackside (or by the train) more than 5 minutes after the last received message from the train (or from the trackside). This timer is not adapted to the Level 3 system needs.

3.8.1.2 The trackside shall consider the communication lost with the train after a smaller timer called “mute timer”. To allow the train to recover from a temporary loss of radio communication this timer could be set to a value of at least 27s (see [6] clause 10.5.2.5)~~shall be longer than T_NVCONTACT + margin~~. As soon as the “mute timer” expires, the VSS section on which the train is located shall be considered as “unknown”.

3.8.1.3 When the train is disconnected from the trackside, the VSS sections part of the MA up to either the limit of the first free TTD, or the first “occupied” VSS section, are set immediately to “unknown”.

3.8.1.3.1 This is done because the train can occupy all VSS which are part of its MA.

3.8.2 Train reconnecting

3.8.2.1 When a train reconnects after the “mute timer” has expired, the VSS sections set “unknown” when the “mute timer” expired can be restored based on the following conditions:

- The VSS sections where the train is located will become “occupied” if the train reports “integrity confirmed”, no change of train data train length was reported since the previous position report and there is no shadow train risk. If these conditions are not fulfilled, these VSS sections will become “ambiguous”.
- The VSS sections in advance of the train covered by the original MA will become “free” if the original MA is still valid on-board, or can be re-issued to the train. If this condition is not fulfilled, these VSS sections will remain “unknown”.
- The VSS sections in rear of the train location become “free” if the train reports “integrity confirmed”, no change of train data train length was reported since the previous position report and there is no risk that another train had entered these

sections. If these conditions are not fulfilled, these VSS sections will remain “unknown”.

3.8.2.2 Note: VSS sections in state “unknown” in rear of the train would of course also become “free” if the TTD is released.

3.9 Sweeping of sections

3.9.1 Sweeping of VSS sections

3.9.1.1 The sweeping mechanism allows clearing VSS with state “unknown” without waiting until the TTD becomes free via the following procedure:

- a) An integer train receives an authorisation (e.g. OS or SR) to move through the “unknown” VSS.
- b) When the integer train enters that VSS, the VSS becomes “occupied” if there is no shadow train risk.
- c) When the integer train exits that VSS, the VSS becomes “free”.

3.9.1.1.1 Note: Sweeping of a VSS with state "ambiguous" is not possible, because the first train which leaves the VSS would trigger the VSS to become "free" while there is still another train (the sweeping train) on the VSS.

3.9.2 Sweeping of TTD sections

3.9.2.1 It could be considered to increase the availability of the infrastructure by using PTD information from “sweeping” trains to recover from TTD failures.

3.9.2.2 It is however not obvious that such a functionality would be feasible for all locations, since TTD is used for safety purpose in the HL3 concept (e.g. to detect ghost trains). Further details for this mechanism are not provided in this paper and are up to the specific implementation.

4 Hazard mitigation

4.1 Introduction

- 4.1.1.1 In addition to the risks which exist in the other ETCS levels, there are two generic risks which have to be taken into account for any Level 3 implementation, including HL3:
- a) Not connected vehicles could be present on the track. Examples are: trains with cab closed, track-train communication failure, trains not fitted with ETCS, vehicles which perform shunting movements, wagons which are not coupled to a loco.
 - b) Such a not connected vehicle could move due to e.g. operational procedures, brakes which have lost their brake power (air pressure reduced after a certain amount of time), defective brakes, unauthorised movements.
- 4.1.1.2 If the trackside is not aware of such a stationary or moving not connected vehicle, another train movement could be authorised over the track where the not connected vehicle is present, resulting in the main Level 3 related hazard.
- 4.1.1.3 The following sections in this chapter describe the different situations in which the VSS states "ambiguous" and "unknown", together with the relevant timers, are used to mitigate the risk mentioned above.

4.2 Protection against non-connected trains

4.2.1 Disconnection of a train

- 4.2.1.1 When there is no communication anymore with a train (due to End of Mission or due to a communication failure, see also 3.8), the train is not known anymore to the trackside.
- 4.2.1.2 The VSS sections on which the train is located when the disconnection is detected by the trackside are immediately set to "unknown" to indicate that a not-connected vehicle can be present on these VSS.
- 4.2.1.3 As the train with a communication failure could have used its MA completely, all the VSS in advance of the last train location which are part of the MA sent to that train shall also be set to "unknown" immediately, but only up to the first TTD which is free.
- 4.2.1.4 As the train can move after the disconnection without the trackside being aware of the movement, the state ~~us~~ "unknown" shall be propagated as soon as the "disconnect propagation timer" expires onto adjacent VSS, forward and backward, until one of the following sections is reached:
- a) Free TTD
 - b) VSS where a train is connected (i.e. "occupied" or "ambiguous")
 - c) VSS part of the MA of the chasing train on the previous TTD
- 4.2.1.4.1 Note: The value of the "disconnect propagation timer" depends on the risk for these movements to occur in the specific location/operation. A value between 5-15 min would seem to be practical. The 5 min to allow a reconnection within the session. But a lower value could be selected. If this risk is mitigated by other means the value could be infinite or several hours.

4.2.1.5 If a TTD section, which is fully/partially part of an MA sent to the train before the disconnection occurred, becomes occupied, the VSS inside this TTD shall immediately be set to “unknown”, up to the next free TTD or up to the next VSS “occupied” or “ambiguous”. This is done since the occupation of the formerly free TTD indicates that the disconnected train moved onto the VSS not yet set to “unknown”.

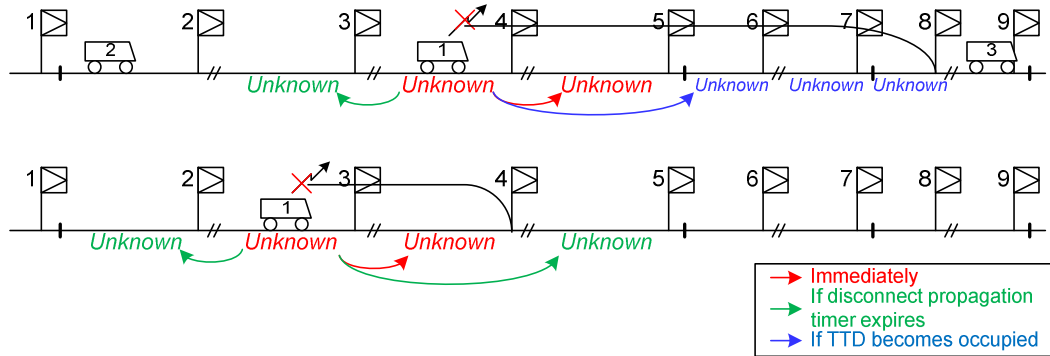

Figure 5: Propagation of "unknown" after disconnection during mission

4.2.1.6 If a chasing train has a FS MA covering a VSS becoming “unknown”, a shortened MA ending at the beginning of that “unknown” section is sent to the chasing train.

4.2.1.7 Note: Propagation nominally stops at including a TTD section with one VSS section at strategic locations is a good mechanism to stop propagation. If the state of this VSS is because this section is either “free” or “occupied” or “ambiguous” (the normal situation), it will indeed stop propagation (see 4.2.1.4 a and b). If its state is “unknown”, it is itself the trigger for propagation by a train.

4.2.1.8 Note: When the TTD section with a point is “occupied” and the point direction is unknown in a degraded situation, propagation is performed over both legs of the point.

4.2.2 Additional protection against ghost trains

4.2.2.1 If a TTD section becomes unexpectedly occupied while all the VSS sections are “free” and no FS MA onto the TTD section exists, the presence of a train not connected to the trackside cannot be excluded and all VSS sections inside the TTD section shall be set to “unknown”. Because there is no information that the ghost train has not moved to neighbouring VSS sections on other occupied TTD, the state “unknown” shall be propagated as soon as the “ghost train propagation timer” expires onto adjacent VSS, forward and backward, until one of the following sections is reached:

- a) Free TTD
- b) VSS where a train is connected (i.e. “occupied” or “ambiguous”)
- c) VSS part of the MA of a train on a neighbouring TTD

4.2.2.1.1 Note: The ghost train propagation timer could be set to the expected time that the TTD could be passed by a ghost train with the SR/SH speed.

4.3 Protection for loss of integrity situations

4.3.1.1 When a train that had reported “integrity confirmed” reports “integrity lost”, a changed train data train length, or the “wait integrity timer” is expired, the VSS sections on which

the train is located become “ambiguous” and the VSS sections left by the train afterwards shall become “unknown”. The “unknown” status of the VSS section shall be propagated, as soon as the “integrity loss propagation timer” expires onto the VSS section in rear of the “unknown” until one of the following sections is reached:

- a) Free TTD
- b) VSS where a train is connected (i.e. “occupied” or “ambiguous”)
- c) VSS part of the MA of a train

4.3.1.2 Note: The “integrity loss propagation timer” is different from the “disconnect propagation timer” and can be relatively long and location specific, depending on the risk assessment of the moment when the lost part of the train would start rolling or moving backwards.

4.3.1.2.1 Note: The wait integrity timer could take into account the max expected delay in the integrity confirmation reports from the train. Nominally not more than the position report frequency.

4.3.1.2.2 Note: The integrity loss propagation timer could take into account:

- a) risk for rolling back after integrity loss (gradient and loss of brake power/pressure) i.e. ± 30 min
- b) risk for wrongfull movement after splitting i.e 5-15 min
- c) short enough to avoid that another train enters the TTD (if not covered by the traffic management system)

4.4 Two reporting trains in one VSS

4.4.1.1 When a second train reports that it has entered a VSS already in state “occupied” in rear of a first train located on this VSS, the VSS is set to “ambiguous”.

4.5 Protection against shadow train hazard

4.5.1.1 The HL3 concept uses the VSS state "ambiguous" to mitigate the shadow train hazard that could occur if an integer train is followed by a not connected train.

4.5.1.2 To achieve this, the status of the VSS is set to “ambiguous” in those VSS for which the trackside is not able to confirm that no other vehicle is located in rear of a connected train (e.g. after start of mission when a train connects to the trackside or VSS section in rear of the train becomes “unknown”, e.g. when a train on the VSS in rear gets disconnected (change from "occupied" to "unknown"), or due to propagation (change from "free" to "unknown").

4.5.1.3 An example of the shadow train hazard is shown in the scenario depicted in [Figure 6](#) and explained in the following clauses. This explanation is followed by a description of the related mitigation measures for a not connected train following on a short distance.

4.5.1.3.1 When an integer train is located on an "ambiguous" VSS (or entering a HL3 area), it means that there may be a train in rear which is not known by PTD to the trackside, see first line in [Figure 6](#) with integer train 1 and ghost train 2.

- 4.5.1.3.2 When train 1 enters the first VSS of a new TTD, this VSS will become "ambiguous" because this risk remains, see second line in [Figure 6](#).
- 4.5.1.3.3 When train 1 reported to have left the VSS in the TTD in rear and the TTD in rear becomes free, the VSS on which train 1 is located could go to "occupied". This because it is confirmed that there is no train on the TTD in rear of train 1. However, a short following train 2 could also be present on this VSS, see third line in [Figure 6](#).
- 4.5.1.3.4 If train 1 leaves the first VSS in the new TTD, the state of this VSS would go to "free" based on the PTD info, see the fourth line in [Figure 6](#). The trackside could authorise another train (3) onto the released infrastructure on which ghost train 2 is still present. This is called the "shadow train" hazard and it is the reason that a mitigation is necessary to avoid that the situation in the third line in [Figure 6](#) can occur.
- 4.5.1.3.5 Note: it is normal to have some time difference between the report from train 1 that he has left the VSS on the previous TTD and the moment that this previous TTD becomes free, due to delay time in the TTD detection and the position reports, delay of on-board integrity monitoring, confidence interval.

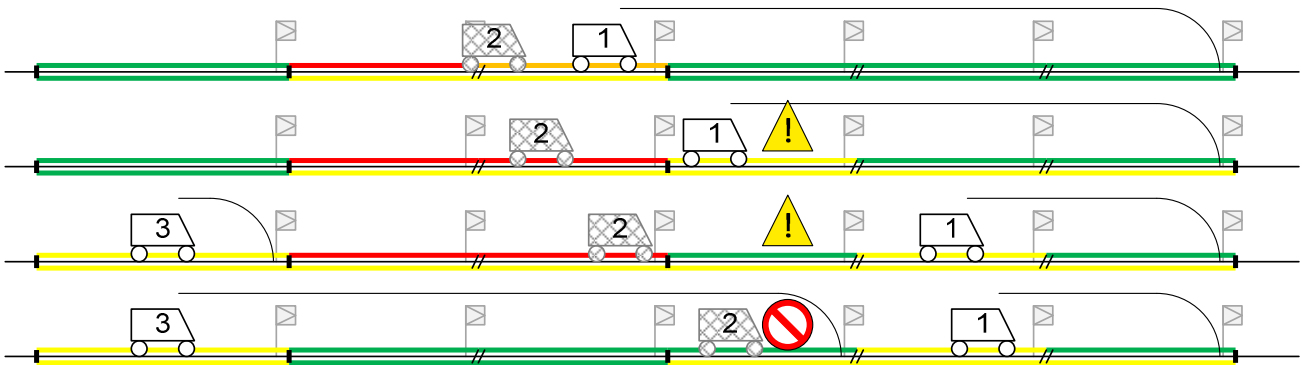

Figure 6: Shadow train hazard

- 4.5.1.4 To prevent that the shadow train is not detected, as shown in step 3 in [Figure 6](#), the following mechanism is defined. When a train has crossed a TTD border where the last VSS of the TTD in rear was in state "ambiguous" when the train was located on this VSS, the VSS in the new TTD are only set to "occupied" when the two events {TTD in rear becomes "free"} and {integer train reports to have left TTD in rear} occur within the "shadow train timer A/B" of the TTD in rear. If this condition is not fulfilled, the VSS in the new TTD are set to "ambiguous". See the scenarios in annex A for examples of this mechanism.
- 4.5.1.4.1 Note: The value of the "shadow train timer A/B" depends on the risk of a shadow train and the expected delays in PTD (integrity and position report interval) and TTD information. A value between 5-10 seconds would seem to be practical. Note that communication delays are mitigated with the use of timestamps of these events.
- 4.5.1.5 Note: A position report can be requested by the trackside from the on-board when passing the TTD limit and the impact of communication delays on the timer evaluation can be minimised by using T_TRAIN information.
- 4.5.1.6 Note: The check on shadow trains in rear of a train with train integrity confirmed is only required once. Once this check is performed (see [4.5.1.4](#)-[4.5.1.2](#)) and the train moves

on, the following VSS sections have the status “occupied” and not “ambiguous” since it can now be excluded that a shadow train is following.

- 4.5.1.7 Note: When the shadow train check (see [4.5.1.44.5.1.2](#)) is performed for the integer train that has already passed the first (very short) VSS sections on a TTD, these passed VSS sections will be set to “free” (i.e. immediate transition from “ambiguous” via “occupied” to “free”).
- 4.5.1.8 Note: Axle counter head information ([information from individual axle counting points](#)) on a detected train movement can be used to improve the shadow and ghost train detection, eliminating the need for a free TTD in rear. Details of this mechanism are out of scope for this concept.

4.6 Rolling backwards

- 4.6.1.1 ETCS provides protection against rolling backwards. The roll away distance after which ETCS will apply the brake can be set through D_NVROLL. It is an implementation choice which roll away distance is allowed.
- 4.6.1.2 Note: If the roll away distance greater than zero is implemented, this distance plus the (worst case) brake distance, as well as multiple roll away, should be taken into account.

5 State machine for VSS

5.1.1.1 The [Figure 7](#) represents the state machine of each VSS. The [Table 2](#) gives the conditions for the transition from each state to each other. The sub-conditions (e.g. #1A, #1B) are always combined with a logical OR to give the result for the main condition, e.g. #4 = #4A OR #4B OR #4C.

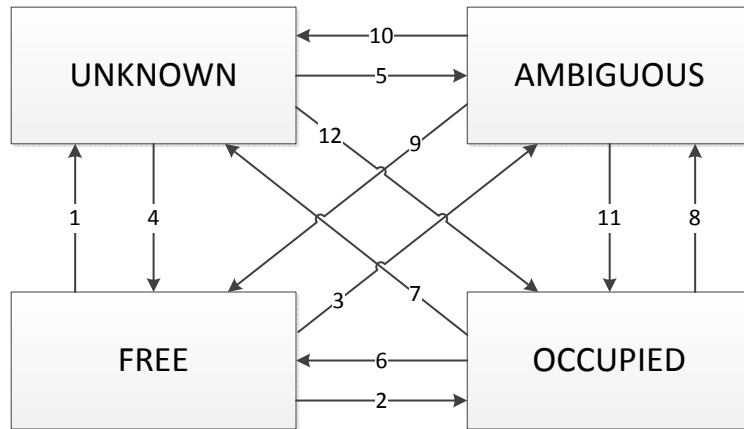

Figure 7: VSS section state diagram

5.1.1.2 VSS states are updated based on the following events:

- PTD information on front-end position (processed first)
- PTD information on rear-end position (including integrity info and (safe) train length)
- TTD information (occupied/free)
- Timer expiration (see [3.3.4.53-4](#))

5.1.1.3 Events are handled in the order of reception as atomic events for all VSS sections.

5.1.1.3.1 Note: This means that time differences between information received from PTD and TTD are by definition taken into account in the state machine.

5.1.1.4 At the start-up of the trackside system all VSS are in state “unknown”.

5.1.1.5 Note: “TTD” without a qualifier like “previous” refers to the TTD of the VSS for which the condition is checked.

5.1.1.6 A timer is only considered as “not expired” if it is running, i.e. was activated by a start event in the context of the concerning train run.

#	Condition	Priority over	Section ref.
#1A	(TTD is occupied) AND (no FS MA is issued or no train is registered for located on this TTD)		4.2.2
#1B	(TTD is occupied) AND (VSS is part of the MA sent to a train for which the mute timer is expired) AND (VSS is located in advance of the VSS where the train was last reported)		4.2.1.3
#1C	(TTD is occupied) AND (there is(/are) only “free” or “unknown” VSS or none between this VSS)		4.2.1.4

#	Condition	Priority over	Section ref.
	and the VSS for which the “disconnect propagation timer” is expired) AND (VSS is located on the same TTD as the VSS for which the timer is expired)		
#1D	(TTD is occupied) AND (there is(/are) only “free” or “unknown” VSS or none between this VSS and the VSS for which the “disconnect propagation timer” is expired) AND (VSS is not located on the same TTD as the VSS for which the timer is expired) AND (VSS is not part of an MA)		4.2.1.4
#1E	(TTD is occupied) AND (there is(/are) only “free” or “unknown” VSS or none between this VSS and the VSS for which the “integrity loss propagation timer” is expired) AND (VSS is located on the same TTD as the VSS for which the “integrity loss propagation timer” is expired)		4.3
#1F	(TTD is occupied) AND (there is(/are) only “free” or “unknown” VSS or none between this VSS and the TTD for which the “ghost train propagation timer” is expired) AND (VSS is not located on the TTD for which the timer is expired)		4.2.2
#2A	(TTD is occupied) AND (train is located on <u>the</u> VSS) AND (VSS where the estimated front end of the train was last reported, was “occupied” after the processing of this previous position report) AND (current state <u>s</u> of the VSS where the train was last reported is not “unknown”)	#3	3.3.3 4.5.1.6
#2B	(TTD is occupied) AND (TTD in rear is free) AND (train location is on <u>the</u> previous TTD) AND (train location is not on <u>the</u> TTD) AND (VSS is <u>the</u> first VSS of <u>the</u> TTD) AND (VSS where the estimated front end of the train was last reported, was “occupied” after the processing of this previous position report) AND (VSS is part of <u>the</u> MA sent to this train)	#3	3.3.3.6
#3A	(TTD is occupied) AND (train is located on <u>the</u> VSS)		3.3.4 4.5.1.2
#3B	(TTD is occupied) AND (TTD in rear is free) AND (train location is on <u>the</u> previous TTD) AND (train location is not on <u>the</u> TTD)		3.3.3.4

#	Condition	Priority over	Section ref.
	AND (VSS is <u>the</u> first VSS of <u>the</u> TTD) AND (VSS is part of <u>the</u> MA sent to this train)		
#4A	(TTD is free)		3.1.1.5
#4B	(integer train <u>located on the VSS</u> reconnects within the same session) AND (VSS is part of <u>the</u> MA sent to this train) AND (VSS is in advance of the VSS where the reconnected train is located)	#5, #12	3.8.2
#4C	(integer train <u>located on the VSS</u> reconnects within the same session) AND (train data train length has not changed) AND (VSS is in advance <u>of,</u> or <u>is,</u> the VSS where the train was located when the connection was lost) AND (VSS is in rear of the VSS where the reconnected train is located) AND (in rear of this VSS and subsequent VSS(s) that had become “unknown” because of the lost connection of this train is a “free” VSS on an <u>“occupied”the same TTD as the train is located on</u>)	#5, #12	3.8.2
#5A	(train is located on <u>the</u> VSS)		3.8.2 4.5.1.2
#6A	(TTD is free)		3.1.1.5
#6B	(integer train has reported to have left the VSS)		3.5
#7A	(train is located on the VSS) AND ((mute timer is expired) OR (EoM))	#8	3.8.1 4.2.1.2
#7B	(train has reported to have left the VSS) AND (train reports “lost integrity” OR PTD with no integrity information is received outside the integrity waiting period OR train reports changed train data train length)	#8	4.3
#8A	(train <u>is</u> located on the VSS) AND (train reports “lost integrity” OR PTD with no integrity information is received outside the integrity waiting period OR train reports changed train data train length)		4.3
#8B	(train is located on the VSS) AND (VSS in rear is “unknown”)		4.5.1.2
#8C	(Another train is located on the VSS)		4.5.1.2

#	Condition	Priority over	Section ref.
#9A	(TTD is free)		3.1.1.5
#9B	(integer train has reported to have left the VSS) AND (the “shadow train timer A” of the TTD was not expired at the moment of the time stamp in the position report)	#10	4.5.1.7
#10A	(VSS is left by all reporting trains)		3.6 3.7 3.3.4.5
#10B	(train is located on the VSS) AND ((mute timer is expired) OR (EoM))		3.8.1 4.2.1.2
#11A	(integer train located on the VSS reported to have left the TTD in rear) AND (the “shadow train timer A” of the TTD in rear was not expired at the moment of the time stamp in the position report) <u>AND (the reported min-safe-rear-end of this train is within the distance that can be covered at the reported speed within the “shadow train timer A” from the TTD limit)</u>		4.5.1.4
#11B	(TTD in rear is free) AND (integer train located on the VSS reported to have left the TTD in rear) AND (the “shadow train timer B” of the TTD in rear for this direction was not expired at the moment of the time stamp in the position report)		4.5.1.4
#12A	(Integer train located on the VSS reconnects within same session) AND (train data train length has not changed) AND (In rear of this VSS and subsequent VSS(s) that had become “unknown” because of the lost connection of this train is a “free” VSS on an “occupied” TTD)	#5	3.8.2
#12B	(TTD is occupied) AND (<u>train is located on the VSS is between the reported front end and the last reported rear end position</u>) AND (VSS where the estimated front end of the train was last reported, was “occupied” after the processing of this previous position report) AND (the train is not re-connecting, i.e. the mute timer was not expired) AND (current state of the VSS where the train was last reported is not “unknown”)	#5	3.9.1

Table 2: Transition between states for VSS sections

6 Annex A: Operational scenarios

Scenario 1 - Normal running of a single train with integrity confirmed by external device

- Step 1 - Train 1 has entered from the left side and occupies VSS 11 (#2A). Integrity is confirmed. Virtual rear end inside VSS 11.
- Step 2 - Train 1 has moved to VSS 12 which becomes “occupied” (#2A). The virtual rear end has not been updated since step 1 (position reports with integrity not available *). The wait integrity timer is running and VSS 11 remains “occupied”.
- Step 3 - Train 1 confirms integrity before the integrity timer expires. Virtual rear end inside VSS 12. VSS 11 becomes “free” (#6B)
- Step 4 - Train 1 has passed the TTD section border and has moved on to VSS 21 which becomes “occupied” (#2A). The virtual rear end has not been updated since step 3 (position reports with integrity not available *). TTD 10 becomes “free” and therefore VSS 12 becomes “free” (#6A).
- Step 5 - Train 1 confirms integrity before the integrity timer expires. There is no impact on VSS 21.
- Step 6 - Train 1 has moved to VSS 22, which becomes “occupied” (#2A). The virtual rear end has not been updated since step 5 (position reports with integrity not available *). The wait integrity timer is running and VSS 21 remains “occupied”.
- Step 7 - Train 1 has moved to VSS 23 which becomes “occupied” (#2A). Integrity is confirmed before the wait integrity timer expires. VSS 21 and 22 become “free” (#6BA).
- Step 8 - Train 1 has moved to VSS 31 which becomes “occupied” (#2A). TTD 20 becomes “free”. VSS 23 becomes “free” (#6A or #6B, whichever comes first).

**) This is degraded behaviour of the TIM functionality and is only included in this scenario to show that the concept is robust against this behaviour.*

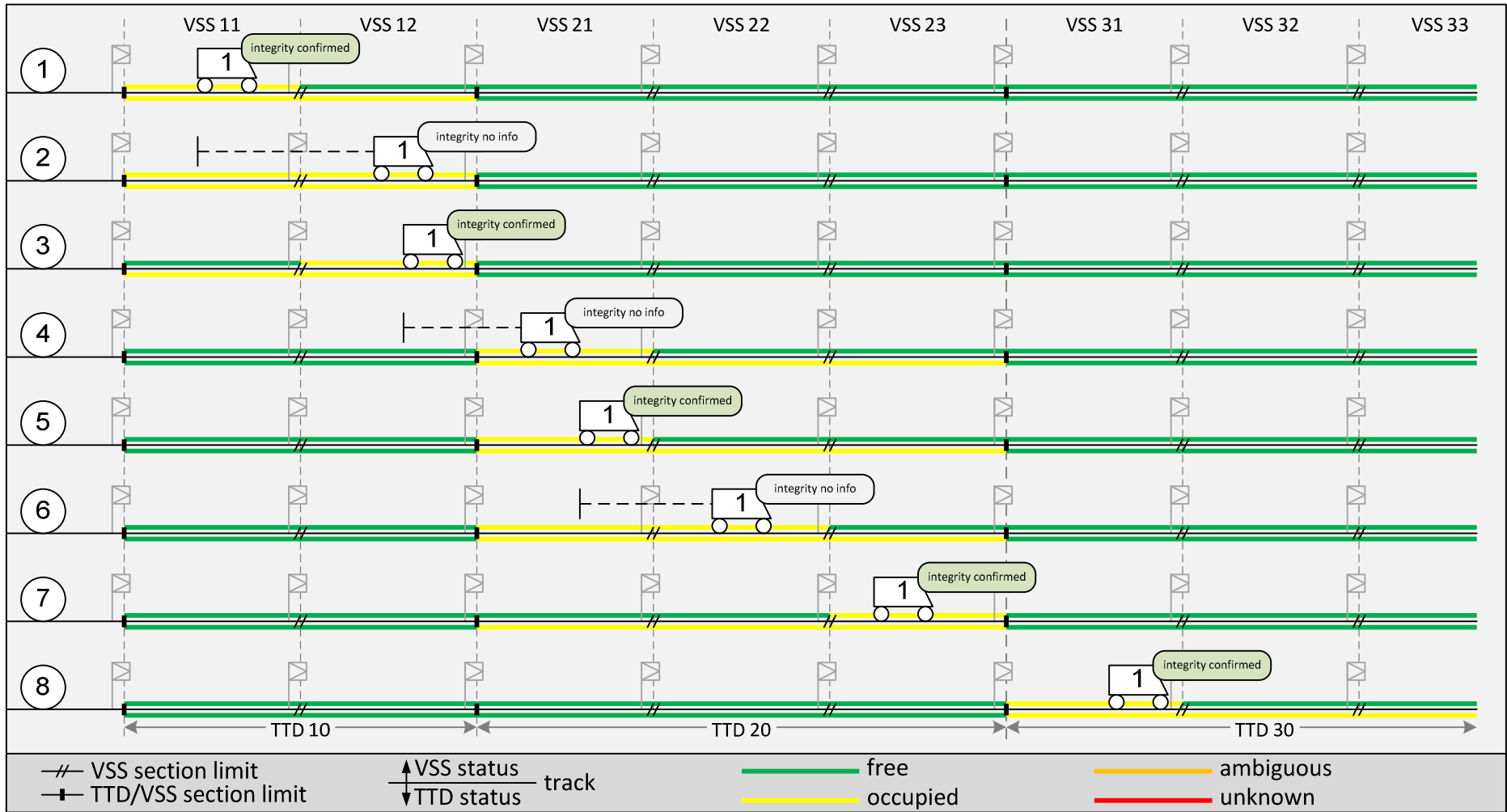

Scenario 2 - Splitting of a composite train with integrity confirmed by external device

- Step 1 - Trainset 1-2 has entered from the left side and occupies VSS 12 (#2A). It has stopped.
- Step 2 - Train 1 and 2 are split. Train 1 remains connected with the trackside and reports the new train data train length. Except for the reporting of the mode change, train 2 is not connected to the trackside. Due to the reported change of train data train length VSS 12 becomes “ambiguous” (#8A). The change of train data train length also starts the integrity loss propagation timer for VSS12.
- Step 3 - Train 1 starts to run again and passes the TTD section border. VSS 21 becomes “ambiguous” (#3A). VSS 12 becomes “unknown” (#10A).
- Step 4 - Train 1 moves on to VSS 22, which becomes “ambiguous” (#3A). VSS 21 becomes “unknown” (#10A).
- Step 5 - Train 1 moves on to VSS 23, which becomes “ambiguous” (#3A). VSS 22 becomes “unknown” (#10A). The integrity loss propagation timer of VSS12 has expired and all VSS in TTD 10 become “unknown” (#1E).
- Step 6 - Train 1 is moving on to VSS 31, with the physical rear still in VSS 23. VSS 31 becomes “ambiguous” (#3A) and VSS 23 remains “ambiguous”.
- Step 7 - Train 1 has physically left VSS 23, with the virtual rear still in VSS 23 (no position report received yet). TTD 20 becomes “free”. As a consequence, VSS 21, 22 and 23 (all VSS sections in TTD 20) go to “free” (#4A for VSS 21, 22 and #9A for VSS 23) and the shadow train timer A for TTD 20 is started.
- Step 8 - Train 1 reports the virtual rear end inside VSS 31 while the shadow train timer A of TTD 20 is not expired. As a consequence, VSS 31 goes to “occupied” (#11A).

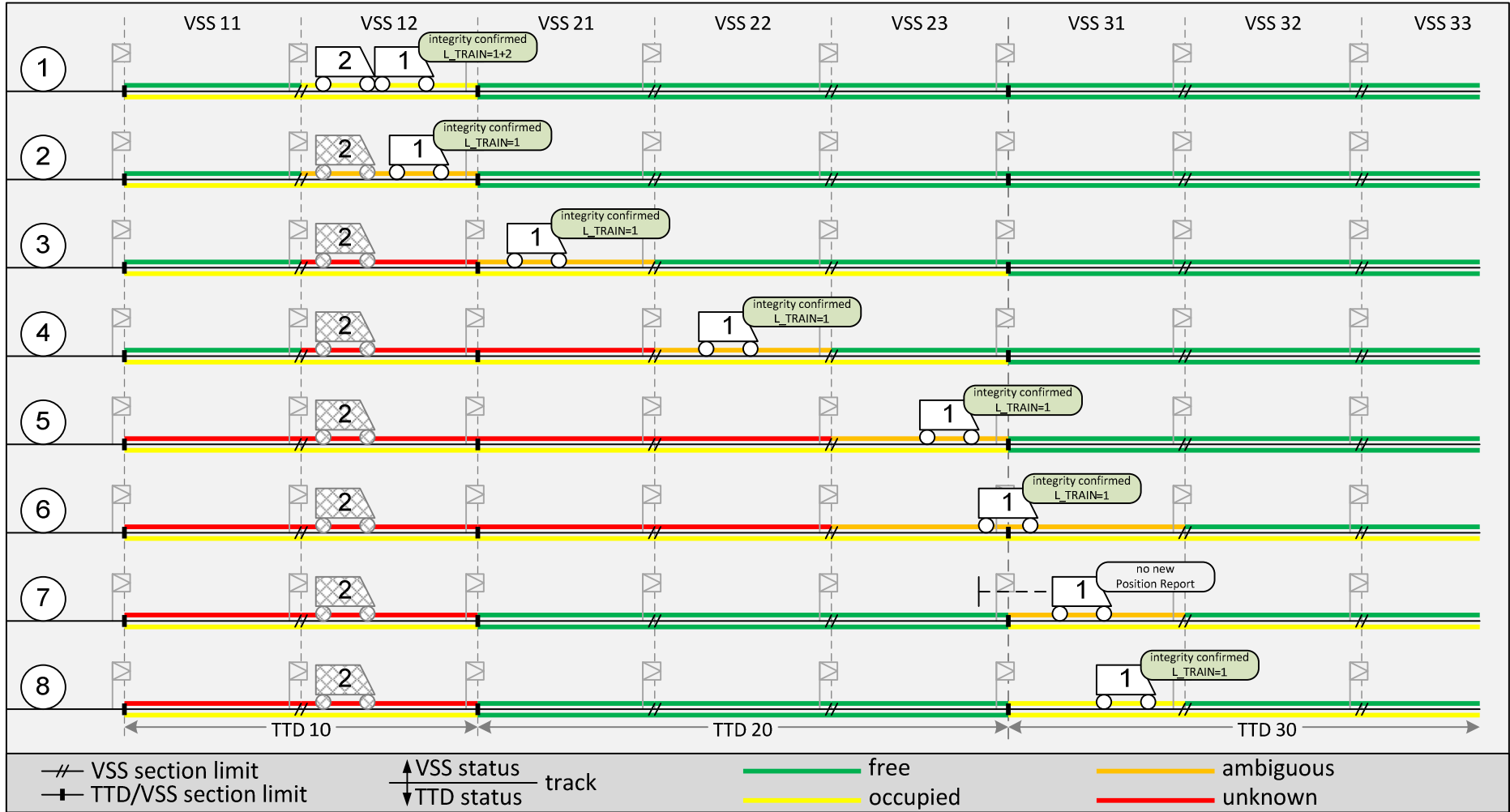

Scenario 3 - Shadow train

- Step 1 - Integer train 1 occupies VSS 12 with state “ambiguous” and a disconnected train 2 is located on the same VSS, just behind train 1. VSS 11 is already “unknown” because the integrity loss propagation timer is has expired. This is the situation some time after split of train 1 and train 2.
- Step 2 - Train 1 moves to VSS 21, which becomes “ambiguous” (#3A). VSS 12 goes to “unknown” (#10A). The shadow train timer of TTD 10 is started.
- Step 3 - Train 1 moves to VSS 22, which becomes “ambiguous” (#3A). VSS 21 goes to “unknown” (#10A). Train 2 starts to follow train 1 (operational procedure).
- Step 4 - Train 1 moves to VSS 23, which becomes “ambiguous” (#3A). VSS 22 goes to “unknown” (#10A). Train 2 moves to VSS 21. TTD 10 becomes free and therefore all VSS in TTD 10 become "free" (#4A).
- Step 5 - Train 1 moves on to VSS 31, but due to a glitch in the radio communication no new position report is received, i.e. no train reported inside VSS 31. TTD 30 becomes occupied, but as long as the mute timer of train 1 does not expire, the VSS in TTD 30 remain “free”. The virtual rear end of train 1 is still in VSS 23 which remains “ambiguous”. Train 2 has moved to VSS 22.
- Step 6 - A position report from train 1 is received again before the mute timer expires. Train 1 has moved on to VSS 32 with the virtual rear end in VSS 31. VSS 31 and VSS 32 both go to “ambiguous” (#3A). VSS 23 becomes “unknown” (#10A). The shadow train timer B of TTD 20 is not started because the virtual rear end is more than the shadow timer B travel distance from the TTD20 border. In the meantime, train 2 has moved to VSS 23 and is close to VSS 31.
- Step 7 - Train 1 is still in VSS 32, but now with virtual rear end in VSS 32. Train 2 has moved to VSS 31. TTD 20 becomes “free”. As a consequence, all VSS sections in TTD 20 go to “free” (#4A). The shadow train timer A of TTD 20 is started. VSS 31 becomes “unknown” (#10A). VSS 32 remains “ambiguous”.
- Step 8 - Train 1 moves on and is followed by train 2.

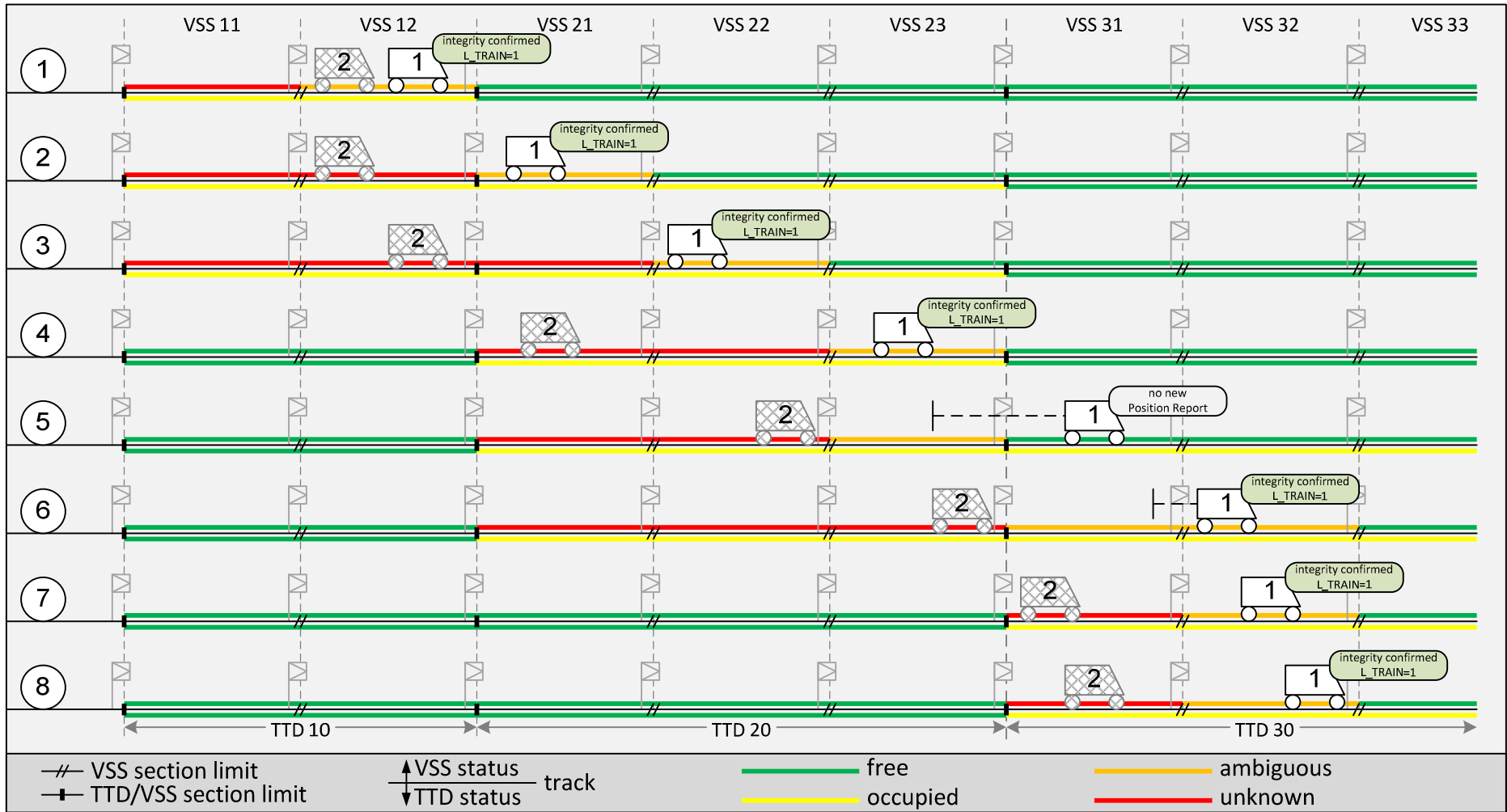

Scenario 4 - Start of Mission / End of Mission

Step 1 - Train 1 is standing on VSS 11 with desk closed and no communication session. All VSS in TTD 10 are “unknown”.

Step 2 - Train 1 performs the Start of Mission procedure, i.e. the session with the trackside is established. Integrity is confirmed. Because train 1 reports its position on VSS 11, this VSS becomes "ambiguous" (#5A).

Step 3 - Train 1 moves to VSS 12 which becomes "ambiguous" (#5A). VSS 11 goes to "unknown" (#10A).

Step 4 - Train 1 moves to VSS 21 which becomes occupied and all VSS in TTD 10 become free. See step 6, 7 and 8 in the scenario on splitting for the details when crossing the TTD border. Step 5 - Train 1 continues to VSS 22 which becomes “occupied” (#2A).

Step 6 - Train 1 performs the End of Mission procedure.

Step 7 - Due to the EoM procedure VSS 22 goes to “unknown” (#7A) and the disconnect propagation timer of VSS 22 is started.

Step 8 - The disconnect propagation timer of VSS 22 expires. All remaining VSS in TTD 20 go to “unknown” (#1C).

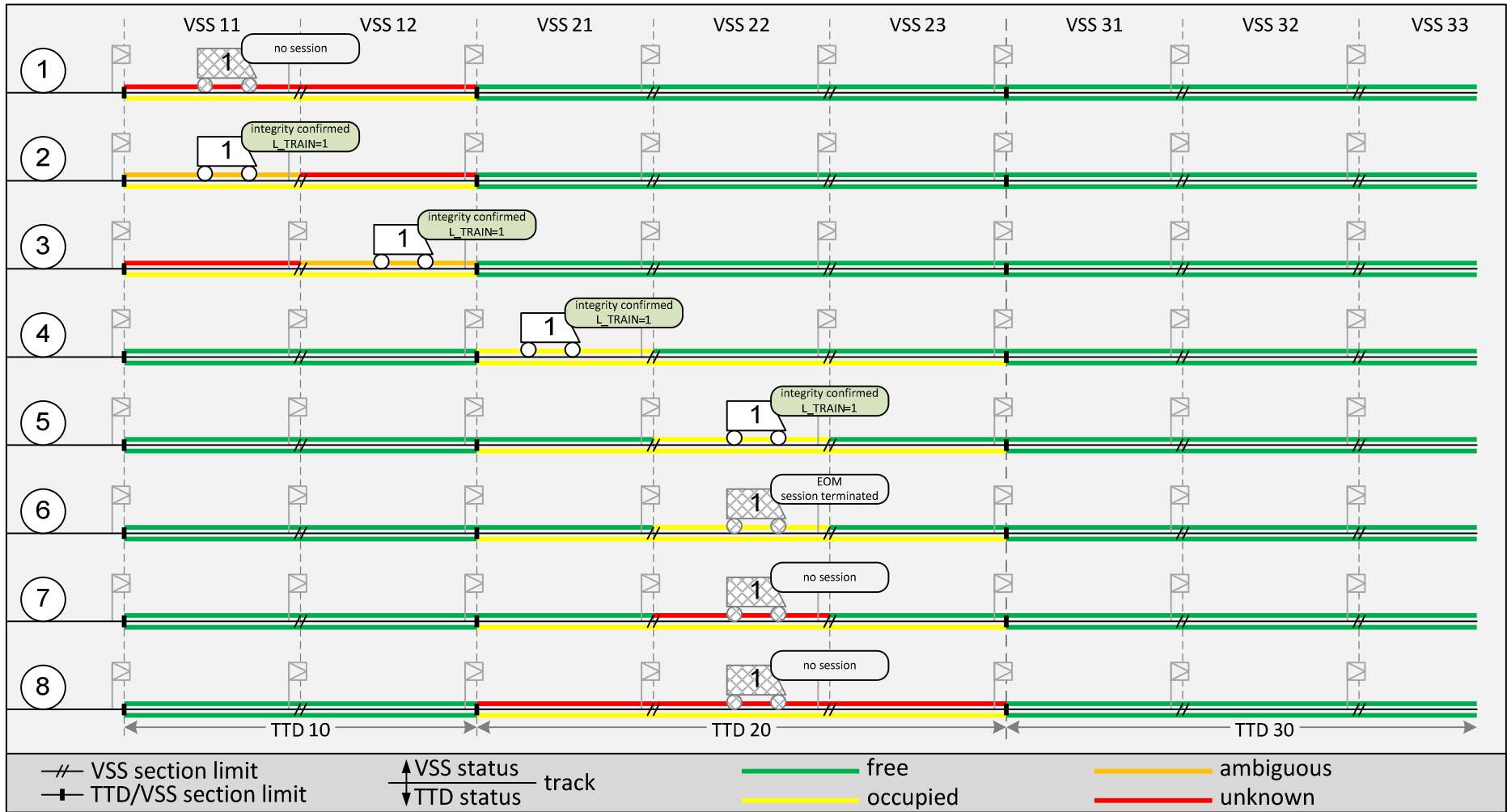

Scenario 5 - Integrity lost

Step 1 - Train 1/2 has entered from the left side and occupies VSS 12 (#2A). Integrity is confirmed. Virtual rear end inside VSS 12.

Step 2 - The connection between train 1 and train 2 is broken. Train 1 reports integrity loss. VSS 12 becomes "ambiguous" (#8A) and the integrity loss propagation timer of VSS 12 is started. Trackside takes the train data train length as the assumed train length. Both parts of the broken train will brake to standstill (TSI requirement for broken trains).

Step 3 - While braking, train 1 moves on and comes to standstill on VSS 21 which becomes "ambiguous" (#3A). VSS 12 becomes "unknown" (#10A). Train 2 comes to standstill on VSS 12. The integrity loss propagation timer of VSS 12 is still running.

Step 4 - The integrity loss propagation timer of VSS 12 expires. All remaining VSS in TTD 10 go to "unknown" (#1E). Train 1 changes the train data train length and confirms integrity related to this new train length *) and moves on to VSS 22 which becomes "ambiguous" (#3A). VSS 21 becomes "unknown" (#10A).

Step 5 - Train 1 moves on to VSS 23 which becomes "ambiguous" (#3A). VSS 22 becomes "unknown" (#10A).

Step 6 - Train 1 is moving on to VSS 31, with the physical rear still in VSS 23. VSS 31 becomes "ambiguous" (#3A) and VSS 23 remains "ambiguous".

Step 7 - Train 1 reports to have left VSS 23, which starts timer B of TTD 20. This position report was received immediately after the train 1 has left VSS 23 and due to the delay time of the TTD detection system, the TTD is still considered occupied. Therefore the position report triggers VSS 23 to become "unknown" (#10A). VSS 31 remains ambiguous.

Step 8 - TTD 20 becomes free and all VSS in TTD 20 become "free" (#4A). This happens while timer B is still running and therefore VSS 31 becomes "occupied" (#11B).

*) If it is not possible to confirm integrity related to the new train length, the scenario would continue from here in the same way, except in step 8, where VSS 31 would remain "ambiguous".

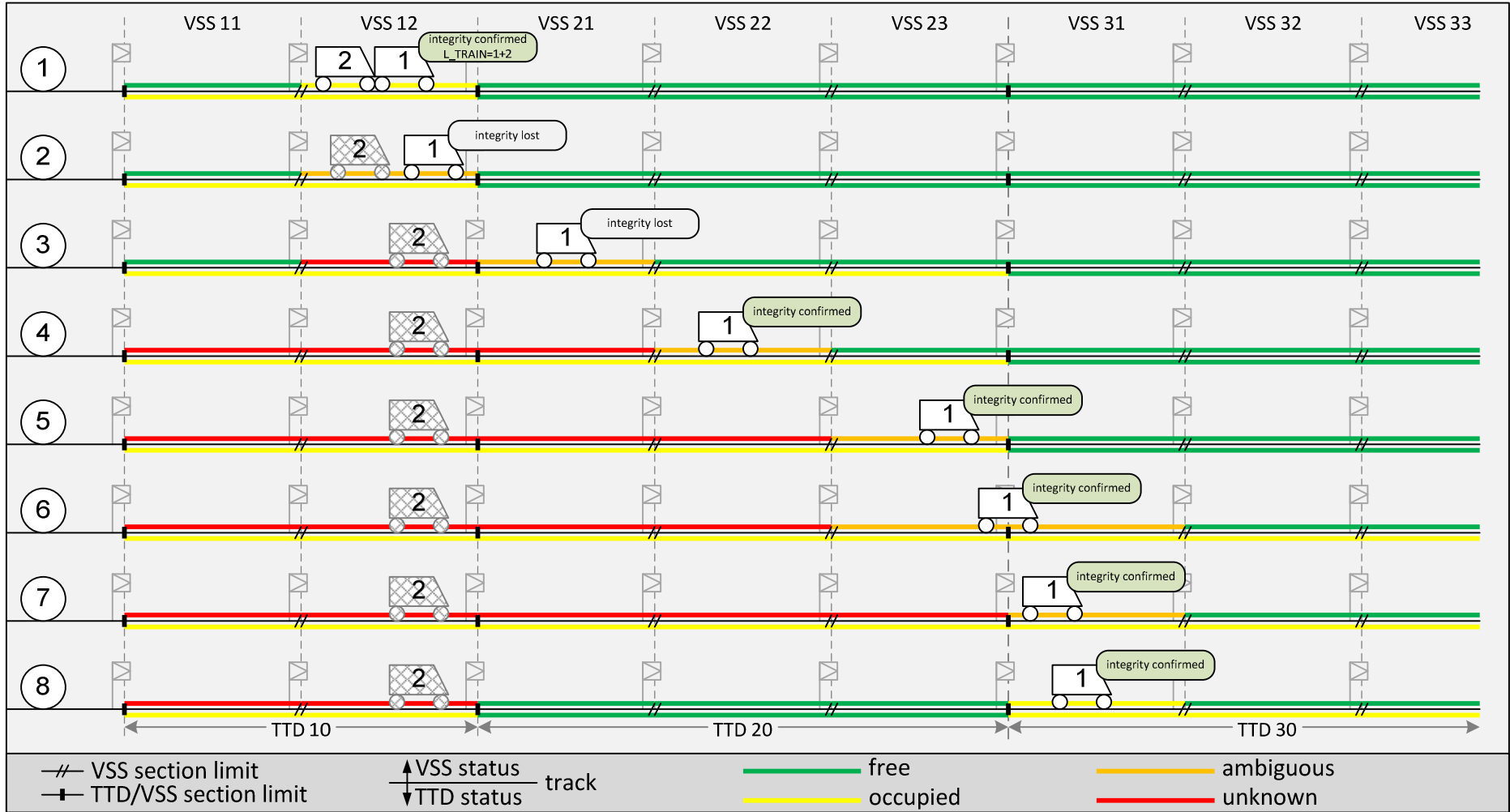

Scenario 6 - Connection lost and reconnect within session

- Step 1 - Train 1 has entered from the left side and occupies VSS 12 (#2A). Integrity is confirmed. Virtual rear end inside VSS 12.
- Step 2 - The radio connection of train 1 is lost.
- Step 3 - The mute timer of train 1 expires. VSS 12 goes to “unknown” (#7A). The disconnect propagation timer of VSS 12 is started.
- Step 4 - Train 1 moves on to VSS 21. The MA of train 1 is up to the end of VSS 22, therefore VSS 21 and VSS 22 become “unknown” (#1B). TTD 10 becomes “free” and VSS 12 goes to “free” (#4A).
- Step 5 - Train 1 moves on to VSS 22 which remains “unknown”. The disconnect propagation timer of VSS 12 expires, VSS 23 goes to “unknown” (#1D).
- Step 6 - Train 1 reconnects within session and reports confirmed integrity. VSS 22 becomes “ambiguous” (#5A). VSS 21 remains “unknown”, and VSS 23 remains “unknown”.
- Step 7 - Train 1 receives OS MA and moves on to VSS 23 which becomes “ambiguous” (#5A). VSS 22 goes to “unknown” (#10A).
- Step 8 - Train 1 moves on to VSS 31 which becomes “occupied” due to the sequence with the shadow train timer, see also scenario 2 (splitting) and 5 (integrity lost) for a detailed description . TTD 20 becomes “free”. VSS 21 and VSS 22 become “free” (#4A) and VSS 23 becomes “free” (#6A).

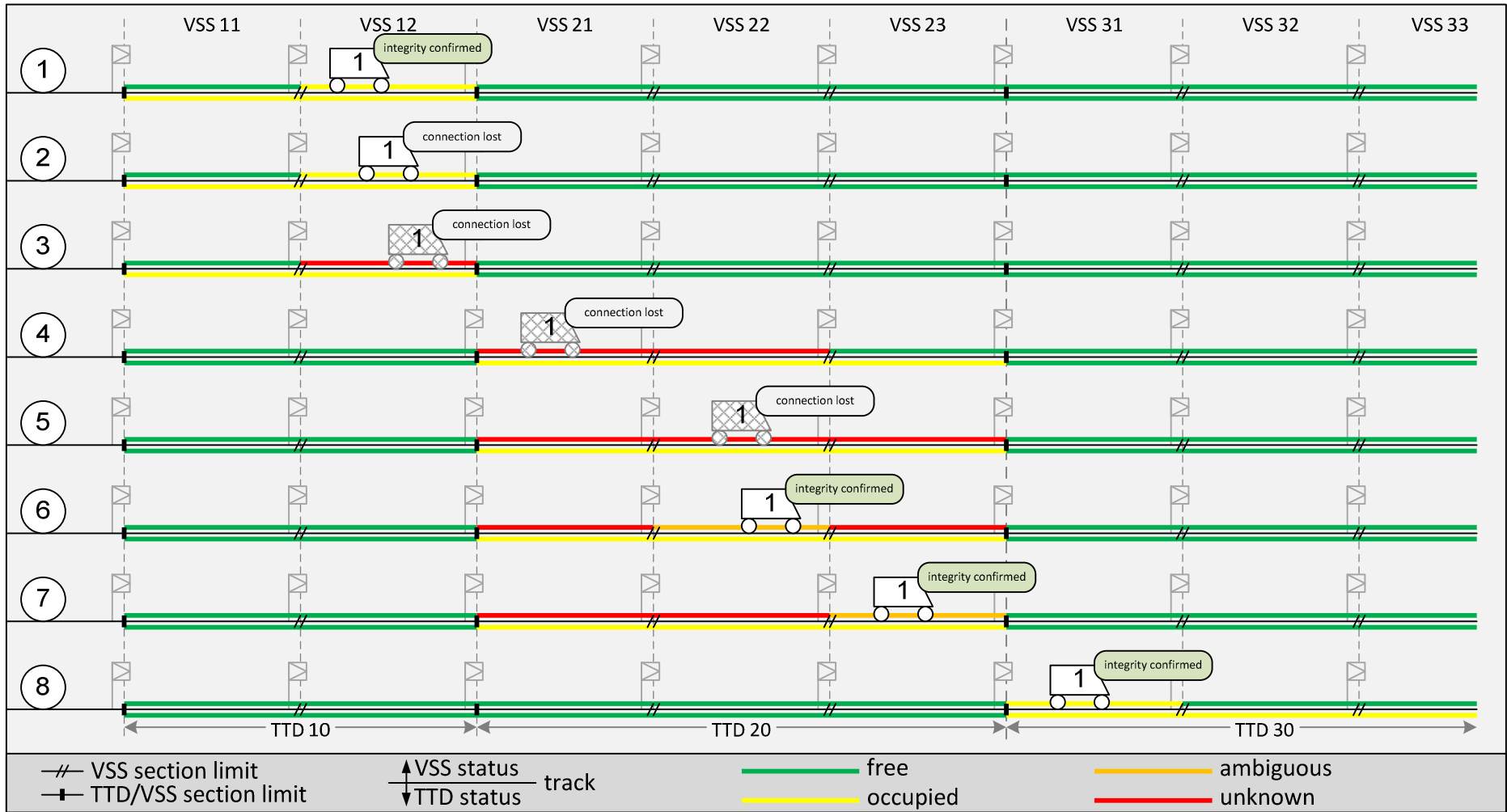

Scenario 7 - Connection lost and reconnect within session with release of VSS

Step 1 - Train 1 has entered from the left side and occupies VSS 21 (#2A). Integrity is confirmed. Virtual rear end inside VSS 21.

Step 2 - Train 1 moves on to VSS 22 which becomes "occupied" (#2A) and VSS 21 becomes "free" (#6B).

Step 3 - The radio connection of train 1 is lost.

Step 4 - Train 1 moves on to VSS 23. However this is not detected because the connection is lost. The mute timer of train 1 expires. VSS 22 goes to "unknown" (#7A). The disconnect propagation timer of VSS 22 is started. VSS23 goes to "unknown" (#1B).

Step 5 - Train 1 moves on to VSS 31. The MA of train 1 is up to the end of VSS 32, therefore VSS 31 and VSS 32 become "unknown" (#1B).

Step 6 - Train 1 reconnects within session and reports confirmed integrity. VSS 23 and VSS31 become "occupied" (#12A). VSS 22 goes to "free" (#4C) and VSS 32 becomes "free" (#4B).

Step 7 - Train 1 leaves TTD 20 and VSS23. As a result VSS 23 becomes "free" (#6A).

Step 8 - Train 1 moves on to VSS 32 which becomes "occupied" (#2A) and VSS 31 becomes "free" (#6B).

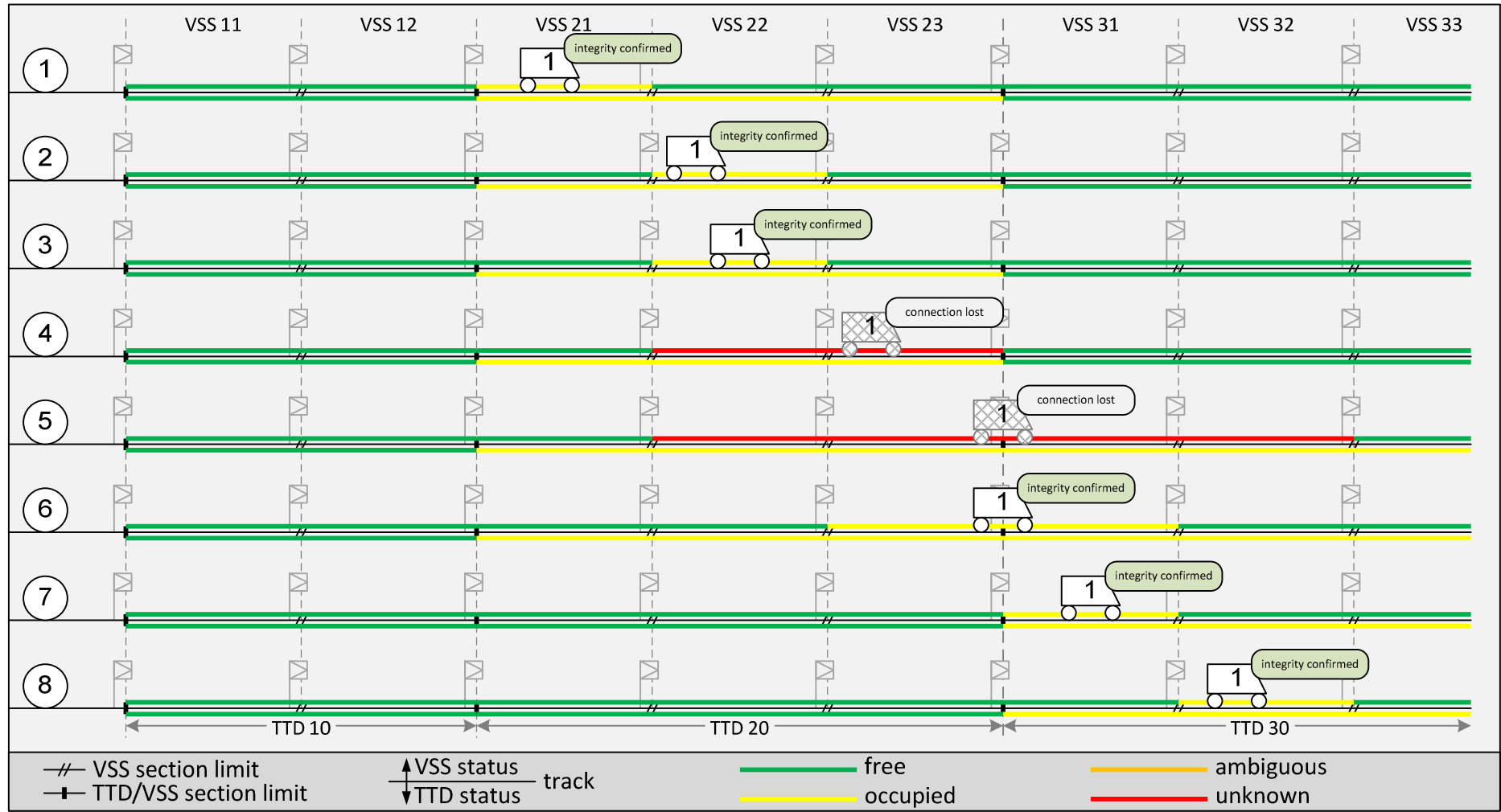

Scenario 8 – Sweeping, jumping and two trains in a VSS

- Step 1 - Train 1 has entered from the left side and occupies VSS 12 (#2A). Integrity is confirmed. Virtual rear end inside VSS 12.
Train 2 has entered from the left side and occupies VSS 11 (#2A). Integrity is confirmed. Virtual rear end inside VSS 11.
- Step 2 - Train 2 receives an OS MA into VSS12 and enters VSS12. VSS 12 becomes “ambiguous” (#8C).
- Step 3 - Train 2 leaves VSS 11 which becomes “free” (#6B). Train 1 enters VSS 21 which becomes “ambiguous” (#3A).
- Step 4 - Train 1 moves on to VSS 23 and reports its position inside VSS 23 which becomes “ambiguous” (#3A). VSS 21 becomes “unknown” (#10A). The VSS 22 also becomes “unknown” via the intermediary state of “ambiguous” because first the update of the front-end position was considered (#3A) and then the update of the rear-end (#10A). Train 2 receives an OS MA and moves to VSS 21.
- Step 5 – Train 2 leaves TTD 10 which becomes free. VSS 12 becomes “free” (#9A). This also starts shadow train timer A of TTD 10. VSS 21 becomes “occupied” as soon as the virtual rear end of train 2 is reported inside VSS 21 due to the sequence with the shadow train timer A (#11A). Train 1 moves on to VSS 31 which becomes “ambiguous” (#3A) and VSS 23 becomes “unknown” (#10A).
- Step 6 – Train 2 moves with the virtual rear end inside VSS 22 which becomes “occupied” (#2A) and VSS 21 becomes “free” (#6B). Train 1 is moving on to VSS 33. VSS 31 becomes “unknown” (#10A), VSS32 becomes “unknown” (#10A) via the state “ambiguous” (#3A) and VSS 33 becomes “ambiguous” (#3A).
- Step 7 - Train 2 moves to VSS23 which becomes “occupied” (#2A) with the virtual rear end inside VSS 23 and VSS 22 becomes “free” (#6B). TTD 30 becomes free and all VSS in TTD 30 become “free”, VSS31 and VSS32 directly via #4A. VSS33 depending on the timing of PTD and TTD information, either via #10A and #4A or directly via #9A.
- Step 8 – Train 2 moves onto TTD 30 and leaves TTD 20 but does not report this position yet. Because TTD 20 becomes free all VSS in TTD 20 become “free” (#6A). VSS 31 becomes “occupied (#2B) to prevent losing the train 2 location.
- *) If train 2 had waited in step 5 for train 1 to have left, TTD 20 sweeping was not required for this situation.

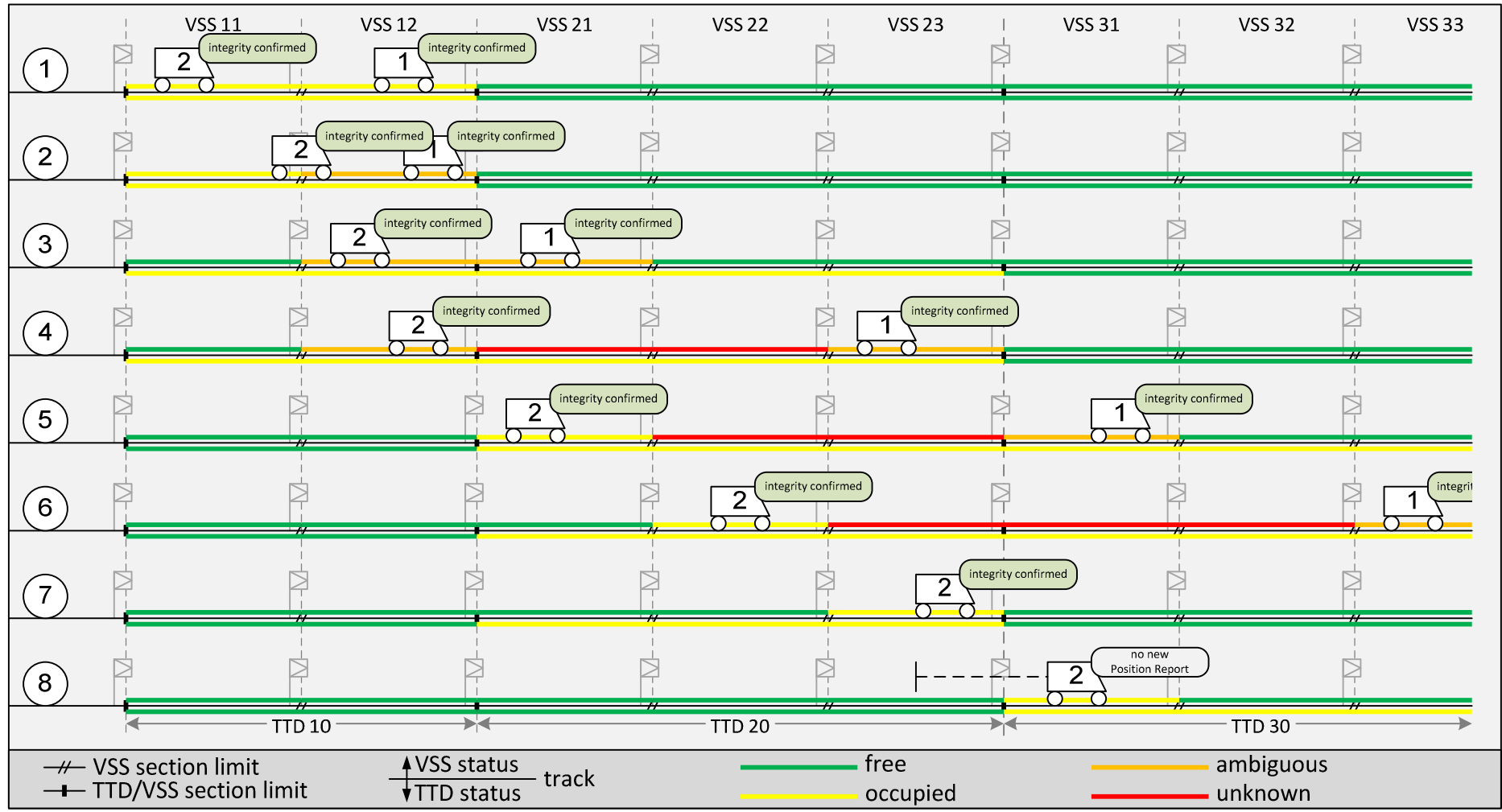

Scenario 9 – Ghost train

Step 1 - Train 1 occupies VSS 23 (#2A). Integrity is confirmed.

Step 2 - Train 2, not known by PTD to the trackside (ghost train), enters TTD 10. VSS 11 and VSS 12 become “unknown” (#1A) and the ghost train propagation timer of TTD 10 is started.

Step 3 - Train 2 is still on TTD 10 and the ghost propagation timer for TTD 10 expires. VSS 21 and VSS 22 become “unknown” (#1F) and VSS 23 becomes “ambiguous” (#8B).

Step 4 - Train 1 moves on to VSS 31 which becomes “ambiguous” (#3A). Train 2 moves to VSS 12 which remains "unknown".

Step 5 –Train 1 moves to VSS 32 and TTD 20 becomes free and all VSS of TTD 20 become free (#4A, #9A). Shadow train timer A is started. Train 1 reports the virtual rear end inside VSS 32. With the front-end update VSS 31 remains "ambiguous" and VSS 32 becomes “ambiguous” (#3A) . With the rear-end update VSS 31 becomes “free” (#9B) and VSS 32 becomes “occupied” (#11A), both due to the sequence with the shadow train timer A.

Step 6 – Train 2 connects to the trackside and VSS 12 becomes “ambiguous” (#5A). Train 1 moves on to VSS 33 which becomes “occupied” (#2A).

Step 7 - Train 2 moves to VSS21 which becomes “occupied” due to the sequence with the shadow train timer (#11A). Train 1 leaves TTD 30 and VSS 32 and VSS 33 become “free” (#6A).

Step 8 – Train 2 moves to VSS22 and loses train integrity. VSS 22 first becomes “occupied” due to the updated front-end position (#2A) . With the update of the rear-end and integrity loss VSS 22 becomes “ambiguous” (#8A) and VSS21 “unknown” (#7B).

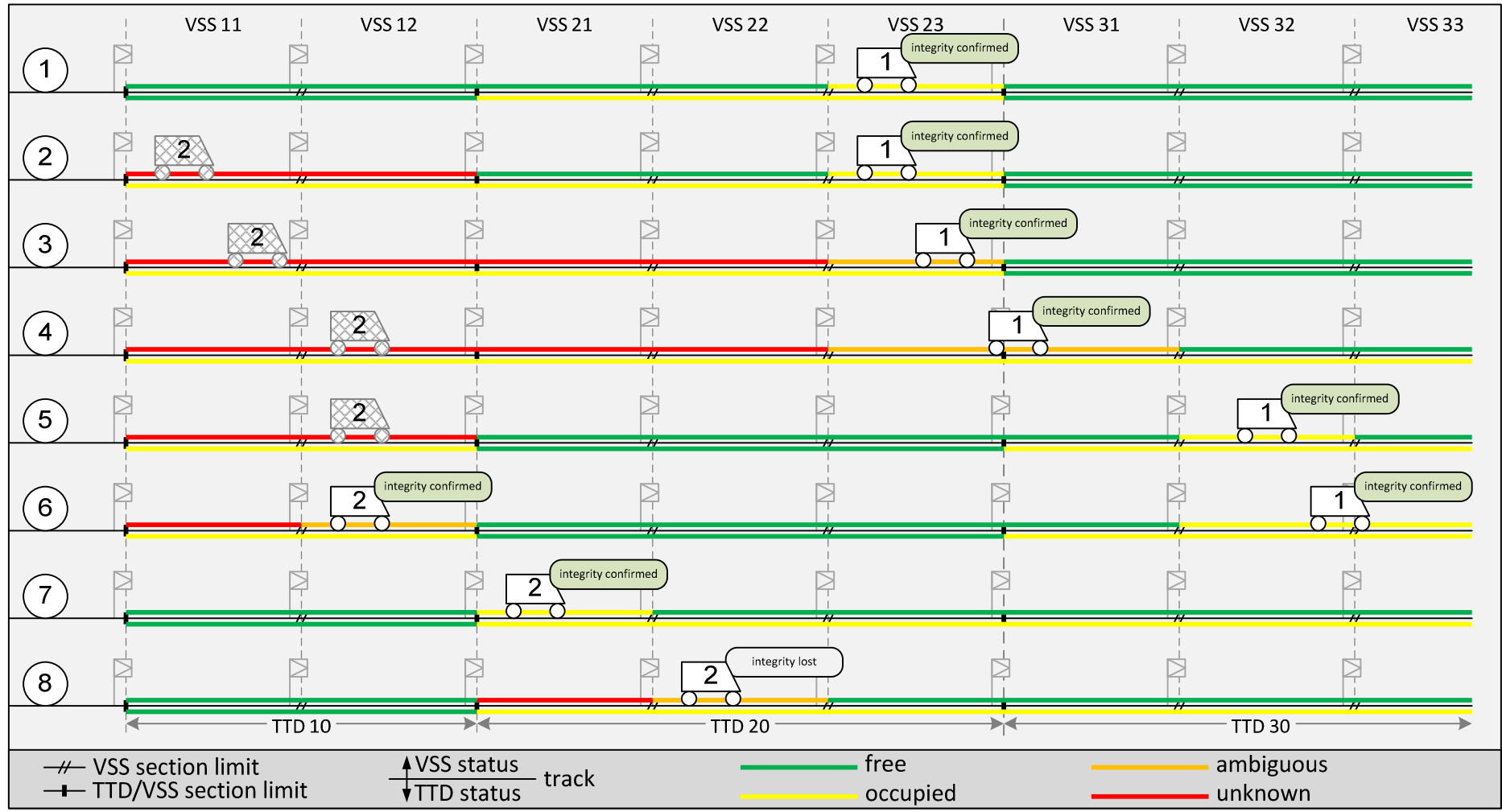

7 Annex B: Mitigation of specification shortcomings

7.1 Introduction

7.1.1.1 There are some shortcomings in the current SRS [1] which can affect operation in L3. All these shortcomings are addressed by Change Request 940 [2]. This chapter describes the issues and possible mitigation if CR 940 is not available.

7.2 Performance issue when leaving an RBC area

7.2.1.1 It is possible that a train leaving an L3 RBC area (RBC handover, level transition) disconnects before sending a position report to confirm that the min safe rear end has left the last VSS of the RBC area.

7.2.1.2 The result is that one or more VSS at the border of the RBC area cannot become “free” based on integrity confirmation from the leaving train.

7.2.1.3 This can be mitigated by covering the last TTD section of an RBC area by a single VSS.

7.3 Performance issue after transition to SH mode

7.3.1.1 When a train receives from the trackside an MA with a Shunting mode profile and enters the acknowledgement area, the driver can acknowledge the Shunting and the train switches directly to SH mode and disconnects from trackside.

7.3.1.2 When the train disconnects, this is considered as an End of Mission, therefore according to [4.2.14.1.1](#), the VSS sections where the train is located become “unknown” and no further FS MA can be extended into these VSS.

7.3.1.3 Therefore, the last TTD before a transition to SH mode should be configured without sub-sections to mitigate the possible impact of propagation (note that if the distance from the SMB to the start of the SH acknowledgement area is shorter than the maximum train length, more blocks should be considered).

7.4 Protection against undetected train splitting

7.4.1.1 Up to version 3.6.0 of [1] it is not foreseen to take the change of train data into account for the integrity status. Therefore, it is possible that a train split which results in a change of the train data train length is not recognised immediately by the trackside. This can result in setting a VSS to “free” where actually the second part of the split train is still located.

7.4.1.2 A mitigation is to end the mission before splitting. This is a normal procedure for train-sets.

- 7.4.1.3 Note: The changed train data information will be repeated by the train until acknowledged by the trackside. This will minimise the risk of releasing infrastructure as a result of not detecting a train split.

7.5 Unspecified reporting behaviour of integrity information

- 7.5.1.1 Up to version 3.6.0 of [1] it is not specified under which conditions the status of the integrity information to be reported to the trackside changes. A trackside implementation should take into account that on-boards up to 3.6.0 could either report several times “integrity confirmed” with increasing train length (L_TRAIN_INT) before a new integrity confirmation is received by the on-board or report “no information” as it is specified for future on-boards in [2].

8 Annex C: Implementation examples

- 8.1.1.1 The Hybrid Level 3 concept allows an increase of capacity and a reduction of trackside train detection on lines where most of the trains are fitted with train integrity. The example below depicts a simple layout with two stations and a stopping place with crossing points in the middle of the connecting line between the stations. The passenger trains are equipped with TIMS functionality and the cargo train not.
- 8.1.1.1.1 The top layout in the example shows a conventional signalling layout with trackside train detection. The depicted train separation is one detection block and one block for the brake distance (with blocks size=B, minimal headway $\approx 2 B$).
- 8.1.1.1.2 The middle layout in the example shows a Hybrid Level 3 configuration with the existing trackside train detection re-used and sub-divided with virtual sub section, increasing the capacity for integer trains. For normal running only one train is allowed in a block (between marker boards). The depicted train separation in rear of an integer train is approximately the brake distance plus the virtual block size plus the periodic integrity reporting time (minimal headway $\approx 1.4B$).
- 8.1.1.1.3 The bottom layout in example shows a Hybrid Level 3 configuration with a reduced trackside train detection. On the line between the point areas, no marker boards are placed only to protect (danger) points. Multiple trains are allowed running between marker boards and the size of the virtual sub sections can be reduced to a minimal size (e.g. 25m) providing a capacity comparable with “moving block”. The depicted train separation in rear of an integer train is approximately the brake distance plus the virtual block size plus the periodic position report time (minimal headway $\approx 1.1B$).

Hybrid Level 3 configuration examples

